

Flygt Exuperior™
Inspired by you. Engineered by us.

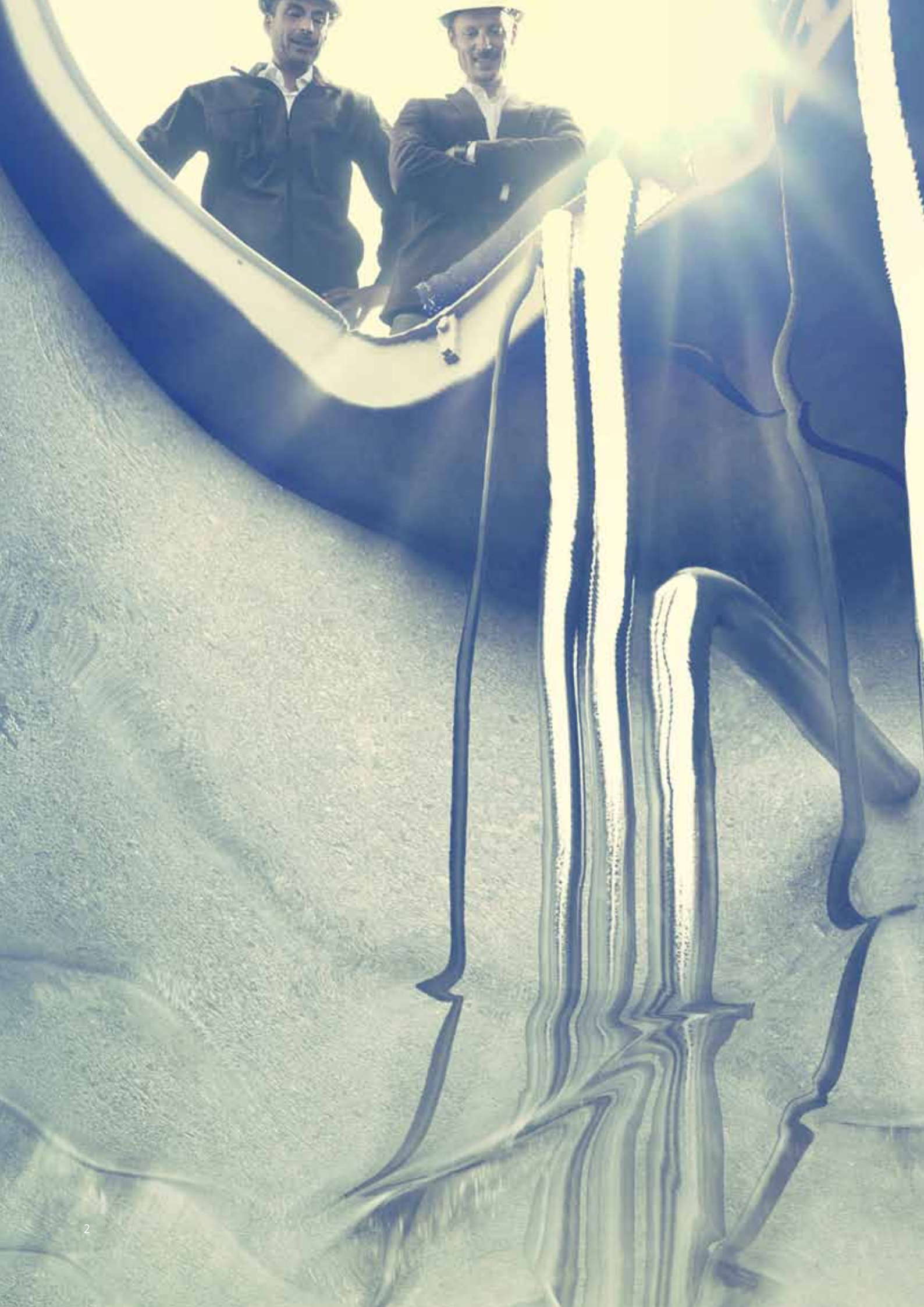



THIS IS FLYGT EXPERIOR™

Who's driving our tradition of groundbreaking innovations? You.

Welcome to a new era in our ongoing tradition of innovative wastewater pumping: an era where engineering excellence and pioneering spirit combine with an unmatched understanding of your needs.

Now, it's time for you to move up to a revolutionary pumping experience called Flygt Experior. It builds on the premise that the most efficient and reliable pump is only achieved when three keystones work seamlessly and completely together, namely the hydraulics, the control, and the motor.

Flygt Experior is our proud contribution to excellence within pumping. Excellence that can only come from the true leaders within wastewater pumping. It builds on our unbeatable pumping and application knowledge. And it is engineered to lead you into the future.

Flygt Experior™. Reliability, efficiency, and simplicity

Flygt Experior gives you the freedom to combine the most technologically advanced features and components, most relevant to your wastewater environment. So you actually have the option to select the most perfect pump possible for your needs.

Flygt Experior incorporates state-of-the-art hydraulics, premium motors, and intelligent controls. In each case, only the products that meet the stringent Flygt demands of reliability and efficiency are selected. Flygt Experior is the stamp of approval that you are getting the best of the best.

The result? State-of-the-art pumping that delivers the ultimate in reliability, efficiency, and simplicity.



Because for you it's all about reliability, reliability. And reliability.

Leaders will lead. Which is why we have once again developed an outstanding breakthrough in wastewater pumping.

The Flygt Experior approved pumps give you the possibility to combine the N-technology and its adaptive functionality, premium efficiency motors, and intelligent control. Each of these components has been engineered by us to achieve top standards of reliability, as well as the ultimate efficient pumping. Flygt Experior approved pumps will be available up to 70kW.

Because the parts are critical to the whole

Flygt Experior is built on the fact that the most efficient pumping is only achieved when premium efficiency motors are combined with superior hydraulics and cutting-edge intelligent controls. It is this combination that gives unbeatable wastewater pumping.

In its totality, Flygt Experior will take you up to a brand new level of reliable pumping. Here you get absolute peace of mind knowing your operations are always running as smoothly and as efficiently as possible.

First N-technology, now the revolutionary Adaptive N

The self-cleaning Flygt N-technology ensures efficient pumping regardless of the wastewater challenges and enables you to save up to 25% on your electricity bills. On top of this, the Adaptive N-hydraulics will help you achieve continuous, trouble-free pumping.

SmartRun™ that puts you in control

SmartRun is the intelligence integrated in a pump control unit that gives you the full benefits of variable speed pumping. SmartRun, with its energy and cleaning functions, is pre-programmed to make it simple and user-friendly for you – from installation through to operation.

Premium efficiency motors with longer lifetime

Flygt Premium efficiency motors are designed and manufactured by us, which makes them optimized for wastewater pumping applications. Our engineering competence ensures a motor that is small and light, yet extremely tough and durable. Importantly, you benefit from a longer bearing and motor lifetime.

Benefits of Flygt Experior™

- Adaptive N-hydraulics further improves the clog-free, energy-saving pump performance
- N-technology is suited for speed regulation, as self-cleaning functionality operates independently of rotational speed
- SmartRun control is pre-programmed to meet specific wastewater customer requirements
- Up to 4% higher motor efficiency than the nominal premium efficiency motor standard
- Single supplier to deliver the optimum pumping solution. This includes the pump, motor, and intelligent control

1930

First Flygt pump manufactured in Lindås, Sweden



1947

Flygt revolutionizes the industry with the world's first submersible pump



1956

The world's first submersible sewage pump with automatic discharge connection

1958

The world's first submersible mixer, SP300



1966

In-house development of motors optimized for wastewater



SmartRun™
 This intelligent control features truly simplified, user-friendly functions that make operations reliable and efficient.

Premium efficiency motor
 We design and manufacture all our motors to be optimized for wastewater pumping applications.

N-technology with its Adaptive N-hydraulics
 The self-cleaning, clog-free N-technology featuring the Adaptive N-hydraulics is developed to achieve trouble free and efficient pumping.

1978
 Launch of the world's first submersible propeller pump



1982
 Development of Grinder pump

1983
 Introduction of the Neva-Clog impeller

1984
 Launch of the revolutionary low-speed, high-efficiency "banana blade" mixer



1985
 Flygt introduces the electronic wastewater controller, PPC

Move up to the highest levels of total efficiency and reliability.

The innovative N-technology revolutionized wastewater pumping with sustained high efficiency and self-cleaning operation, thereby enabling lower total cost of ownership. N-technology gives you the option to customize your pump solution by choosing cast iron, Hard-Iron or chopper hydraulics to meet your specific requirements for reliable operation. This enables you to achieve substantial energy savings by 25% on your electricity bills.

The semi-open impeller and the relief groove work together to achieve self-cleaning ability. The N-impeller blades with back swept leading edges, together with the guide pin, sweep solids away from the center to the perimeter of the inlet. When the solids get to the perimeter of the inlet, they get caught inside the relief groove and slide along the tip of the impeller vane and out of the pump.

Then, in our quest for improvement, we worked further on increasing the reliability of the world's best hydraulics. The result is the Flygt Adaptive N-hydraulics, proof that the best can truly get better.

Get to know the extended Adaptive N-range

The Adaptive N-hydraulics further improve the self-cleaning characteristics of N-technology with unmatched clog-free performance. This is achieved through the unique axial movement of the Adaptive N-impeller.

How the self-cleaning Adaptive N-hydraulics work

The Adaptive N-impeller is designed to move axially upwards when needed, allowing the most bulky of rags and toughest of debris to pass through smoothly. After the debris has passed, the hydraulic pressure returns the impeller to its original position.

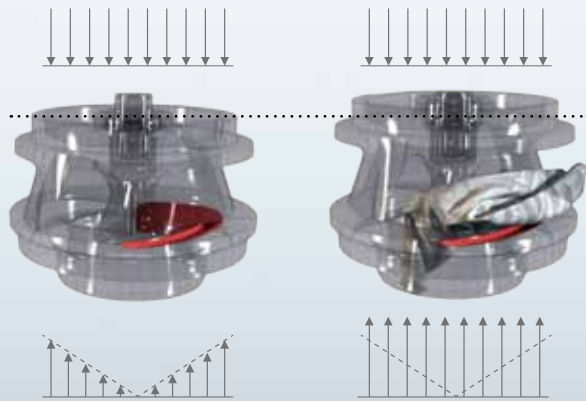

Fig 1: Hydraulic force distribution in normal operation

Fig 2: Force distribution when debris enter the impeller

One small jump for us, a giant leap in cost savings for you

The axial movement of this hydraulic reduces stress on the shaft, seals, and bearings, thereby extending their lifespan. Ultimately clog-free performance requires almost none, or at the very most, simple maintenance and servicing. All in all, the Adaptive N-hydraulics is your assurance of highly economical and reliable pumps that give you peace of mind.

1992
First direct drive mixer, SR4600-series

1993
Launch of High-performance level regulator

1993
Introduction of the second generation Mix-Flush valve

1994
Launch of the world's largest submersible sewage pump

1996
The world's first prefabricated, self-cleaning pump station (TOP)



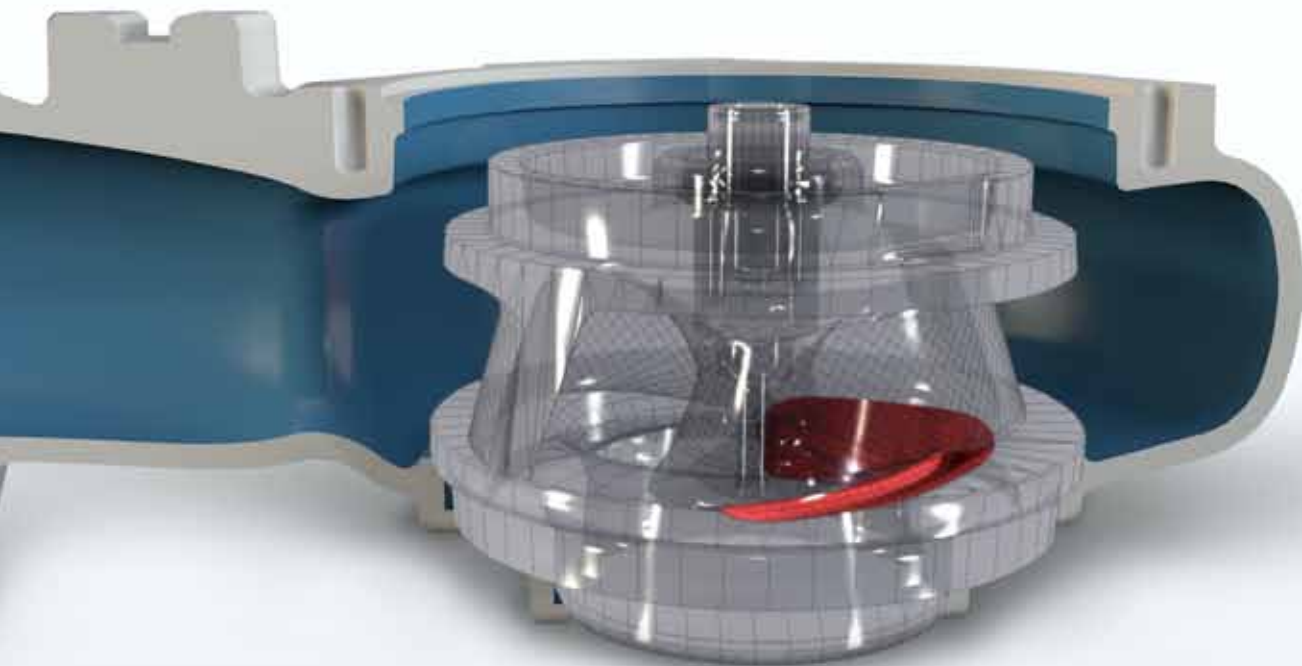

N-technology gives you freedom to choose Cast iron, Hard-Iron™ or chopper

Choose between the standard cast iron hydraulic modules for typical wastewater applications, Hard-Iron modules for extremely abrasive or corrosive applications, and chopper modules for chopping long fibers or solids in wastewater. It is even possible to switch modules to suit altered operating conditions.

The Hard-Iron module advantage

Both the impeller and insert ring consist of Hard-Iron material, which is a high-strength alloy with a 25% chromium content. This provides exceptional wear resistance for highly abrasive and corrosive wastewater applications. Hard-Iron is ten times more durable than conventional cast iron and twice as durable as duplex stainless steel.

The superior chopper module

The chopper module cuts tough solids without clogging and sacrificing pump efficiency. Both the impeller and insert ring are made of Hard-Iron. Typical applications include wastewater facilities, agriculture, aquaculture, food processing, and pulp and paper.

Cast iron

Hard-Iron™

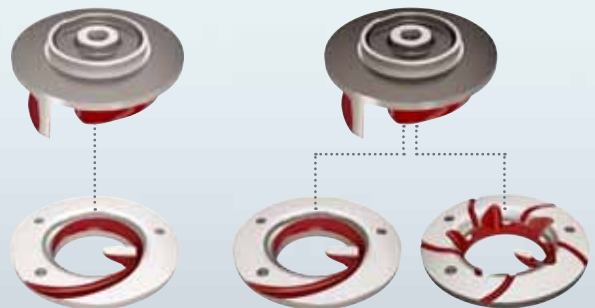

Benefits of Flygt N-technology and its Adaptive N-hydraulics

- Maximum availability due to the self-cleaning, clog-resistance impeller design
- Sustained high efficiency—reduced energy costs up to 25%
- Flexible and modular design to suit any application
- Minimized unplanned maintenance costs

1996

New series of more power-dense motors designed for medium capacity pumps



1996

Pump cleaning function introduced in a control unit, APF



1997

Launch of the revolutionary N-technology



1998

First jet-mixer for dry and submersible installations with N-technology



SmartRun™ is a pre-programmed control with all-new patented functions dedicated to wastewater pumping stations.

FLYGT EXPERIOR™: INTELLIGENT CONTROL

Intelligent control for reliable pumping is now in your hands

Ever wondered why you experience problems with clogging of pumps and costly maintenance when they are equipped with a variable speed drive?

The reason could well be that crucial operational parameters have not been correctly established for your wastewater pumping station. Parameters that are often complicated to set, and ultimately, result in you not getting the best out of your pump.

SmartRun™ – all the intelligence you need in one control

SmartRun is integrated in a pump control unit and is all the intelligence you require in order to capitalize

on the benefits of variable speed pumping.

SmartRun incorporates intuitive, user-friendly functions making it highly appealing. The fact that all parameters have been pre-programmed makes work much simpler for you. To begin with, installations are speedy, simple, and cost-effective. Then, all you really have to do is press auto for start-up.

All the while, you will have absolute peace of mind knowing that all functions will run in the most optimal manner possible for your particular pumping application. More importantly, these functions have been developed and optimized to achieve energy savings and maximum cleaning within wastewater pumping.

2000

Development of the Plug-in Seal™



2000

Flygt grinder control launched



2004

Introduction of Dura Spin™

2007

Launch of N-Pump series with Insert ring and Hard Iron™ impeller



Outstanding patented energy and cleaning functions

Function	Solution	Result
Energy-optimal speed finder	Steadily secures speed to optimal energy level without the use of a flow meter or any other external measurement equipment.	Cost savings with reduced energy consumption.
Pump cleaning	The pump cleaning sequence detects any abnormal blockage of the impeller and initiates an automatic cleaning sequence by momentarily reversing the pump.	Cost savings due to resolved clogging if it occurs.
Sump cleaning function	In a special sequence, the pump overrides the stop level to pump down to snoring level for the purpose of removing oil, grease, and other floating pollutants from the water surface.	Cleaner sump with less odor, reduced labor and maintenance costs. No need to pump down and clean the sump manually.
Pipe cleaning function	Regular full speed flushing of the pipe system.	Less sedimentation in the pipes and therefore less wear and tear leading to prolonged intervals between service calls and reduced maintenance costs.
Pump and drive protection	Temperature and leakage protection built into the drive.	Sends alarm when temperature is too high or if leakage occurs in the pump.
Soft start and stop	Speed ramping reduces start current flow and transients at pump stop.	Smoother and gentler running of the pump system leading to less damage and wear and tear.
External fieldbus communication	System is compatible with fieldbus (ModbusRTU) APP, MAS, and other control units.	Simple standard protocol communication with other monitoring and control units.

Benefits of SmartRun™

- Simplified intelligence: pre-programmed and user-friendly setup
- No need for special competence: minimal costs incurred during start-up and operations
- Reduced maintenance costs due to pre-programmed sump and pipe cleaning functions
- The pump cleaning function is automatically triggered in the unlikely event of clogging
- Energy consumption reduced by 30%

2008
Launch of chopper insert ring



2009
Introduction of Active Seal™ seal system



2009
Launch of Adaptive N-technology

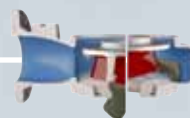

2009
The world's first LSPM motor technology for mixers

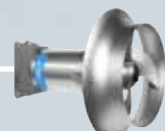

New motors engineered for premium efficiency and longer lifetimes

As the world's leading designer and manufacturer of motors for wastewater pumping, with over 50 years of experience, we now offer you Premium efficiency motors up to 70kW.

Flygt specialists and engineers utilize cutting-edge calculation programs to develop motors optimized for wastewater pumping applications. These are tested in our own Canadian Standards Association (CSA) certified test laboratory and result in Premium efficiency motors with highest reliability.

Nothing beats the cool motor

Flygt Premium efficiency motors are engineered to concentrate the losses around the stator in order to be as cool as possible. This not only prolongs the lifespan of the motor and bearings but also achieves efficient cooling.

Our innovative Line Started Permanent Magnet motors up to 15kW

The world's first LSPM motor technology has been featured in Flygt compact mixers since 2009, so we have extensive experience. With this, we have achieved a motor up to 15kW that is both powerful and extremely efficient. This gives you up to 4% higher efficiency than the nominal value of the International premium efficiency standard (IEC 60034-30) set by European regulations and the NEMA standard.

Flygt LSPM motors are designed to utilize less current on the data plate, which allows for smaller cables and protective devices. This makes it simple to retrofit your pump on your existing control panel. The flexible LSPM motors can be started using all common starting methods. All our engineering efforts also focus on ensuring we have motors that are as slender and light as possible.

Benefits of Premium efficiency motors

- International premium efficiency standard
- Lower motor temperature prolongs motor and bearing lifespan
- Optimized for wastewater pumping applications
- All common starting methods possible



2011

SmartRun™, the new intelligent control for wastewater pump stations



2011

Low-capacity wastewater pumps with Adaptive N-technology launched



2011

Premium efficiency motor range launched for wastewater pumps

RELIABILITY. EFFICIENCY. SIMPLICITY.

Flygt Exuperior™

Inspired by you. Engineered by us.

Throughout the years, you have been our portal into the world of wastewater pumping. We have listened to you, and made it our priority to understand your challenges and needs. You have inspired us to achieve engineering excellence through our ideas and innovations. Flygt Exuperior combines superior hydraulics, cutting-edge

intelligent controls, and top-of-the-line motor because these are the critical components to efficient and reliable pumping. And, backed up by the industries most extensive sales and service organization, this is what Flygt Exuperior is developed to deliver time and time again.

Top performance with a broad capacity range

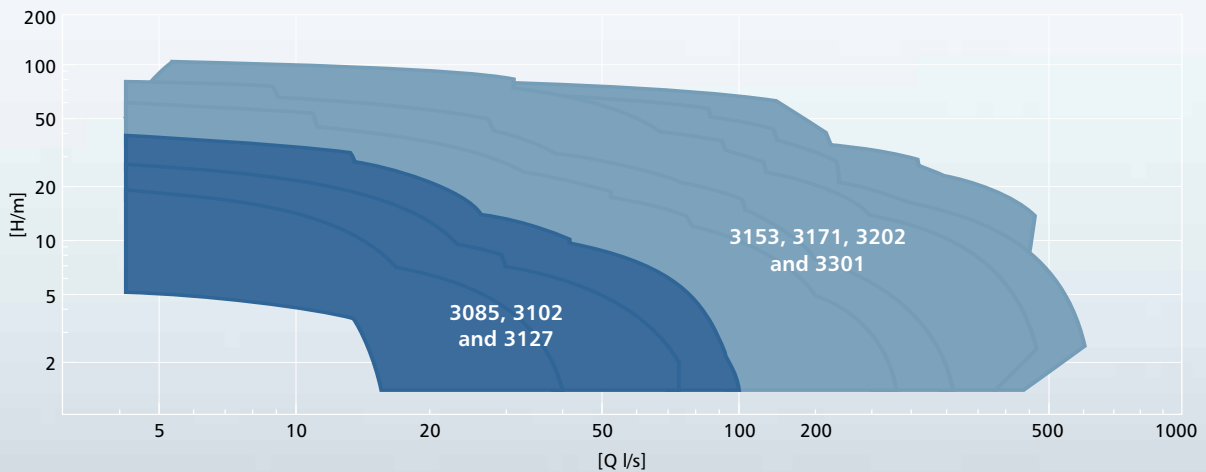

Power ratings and sizes

Pump model	3085	3102	3127	3153	3171	3202	3301
Rating, kW	1.3–2.4	3.1–4.2	4.7–7.4	7.5–15	15–22	22–47	45–70
Discharge, mm (in)	80 (3")	80 (3")	80 (3")	80 (3")	100 (4")	100 (4")	150 (6")
		100 (4")	100 (4")	100 (4")	150 (6")	150 (6")	250 (10")
		150 (6")	150 (6")	150 (6")	250 (10")	200 (8")	300 (12")
				200 (8")		300 (12")	
			250 (10")				
SmartRun™	SRC 300-series						
Rating, kW	4	5.5	7.5	15	22	45	75
Current, A	18 9.5	25 14	39 18	61 30	90 46	90	150
Voltage, V	230 380-440	230 380-440	230 380-440	230 380-440	230 380-440	380-440	380-440

Flygt Exuperior™

Pump model		3085	3102	3127	3153	3171	3202	3301
Hydraulics	N-technology				•	•	•	•
	Adaptive N	•	•	•				
	Hard-Iron™	•	•	•	•	•	•	•
	Chopper			•	•	•	•	
Intelligent control	SmartRun™	•	•	•	•	•	•	•
Motor	Premium efficiency motors	•	•	•	•	•	•	•



Xylem |'zīləm|

1. The tissue in plants that brings water upward from the roots
2. A leading global water technology company

We're 12,000 people unified in a common purpose: creating innovative solutions to meet our world's water needs. Developing new technologies that will improve the way water is used, conserved, and re-used in the future is central to our work. We move, treat, analyze, and return water to the environment, and we help people use water efficiently, in their homes, buildings, factories and farms. In more than 150 countries, we have strong, long-standing relationships with customers who know us for our powerful combination of leading product brands and applications expertise, backed by a legacy of innovation.

For more information on how Xylem can help you, go to xyleminc.com