

SOLUTIONS FOR HEALTH FACILITIES

Solutions pour
les établissements
de santé





Summary

Sommaire



Introduction	4
Who are we?	4
Neop® designed to cover all your needs	6

01. Medication management system **10**

1.1. Internal pharmacy equipment **12**

Wire chromed shelves	12
EasyDrawer® telescopic shelves	13
Opti Stock® stores	14
Opti Stock® supply trolley	15
Picking station	16

1.2. Solutions for storage **17**

Pharmacy cabinets	17
Neop® mobile storage cabinets	18
Storage cabinets and columns for pill dispenser trays	20

1.3. Solutions for transfer **21**

Transfer cabinets	21
Neop® transfer trolleys and cabinets	22
Trolleys and pharmacy box for transport	24

1.4. Solutions for medicine distribution **25**

Trolleys for medium stay and long stay	25
Neop® distribution trolleys	27

1.5. Solutions for medicine preparation **33**

02. Care management and equipment **34**

2.1. Nurse station equipment **36**

Neop® modular nurse stations	36
Nurse station with furniture with laminated fronts	38

2.2. Dressing trolleys **39**

Neop® dressing trolleys	39
Agily® dressing trolleys	41
Resine® dressing trolleys	42

2.3. Emergency trolleys **43**

2.4. Equipment for operating theatre **44**

2.5. Dental prosthesis cleaning system **47**

2.6. Multisensory nursing trolley **48**

03. Pharmacy accessories **50**

Pocket pill cutter and crusher	51
Dental box	52
Daily and weekly medicine dispensers	53

04. Laundry and waste range **54**

Linen shelving trolleys	56
Room trolleys	58
Laundry hampers	60
Clamp collection trolleys	62
Dirty linen trolleys	63
Linen transport cabinets	64
Wire chromed trolleys and shelving systems	65

05. Patient file management **66**

Patient file trolleys	67
Mobile computing stations	68
Computerisation solutions for trolleys	69

06. Catering management **70**

07. Technical aids for medical staff **72**

Transfer boards	73
Pinel® restraint system	74



 Introduction	4
Qui sommes-nous ?	4
Neop® conçue pour couvrir tous vos besoins	6

01. Circuit du médicament et des DM **10**

1.1. Aménagement de PUI	12
Rayonnage en fil chromé	12
Rayonnage télescopique EasyDrawer®	13
Rayonnage Opti Stock®	14
Chariot d'approvisionnement Opti Stock®	15
Postes de cueillette	16
1.2. Solutions de stockage	17
Armoires à pharmacie	17
Armoires de stockage mobiles Neop®	18
Armoires et colonnes de stockage pour piluliers	20
1.3. Solutions de transfert	21
Armoires de transfert	21
Chariots et armoires de transfert Neop®	22
Chariots et bacs de transport	24
1.4. Solutions de distribution du médicament	25
Chariots pour le moyen et le long séjour	25
Chariots de distribution Neop®	27
1.5. Solutions pour la préparation des médicaments	33

02. Mobilier de soins et équipements de service **34**

2.1. Aménagement de salles de soins	36
Salles de soins modulaires Neop®	36
Salles de soins menuisées	38

2.2. Chariots et guéridons de soins	39
Chariots de soins Neop®	39
Guéridons de soins Agily®	41
Guéridons de soins Résine®	42
2.3. Chariots d'urgence	43
2.4. Équipement pour le bloc opératoire	44
2.5. Système de nettoyage pour prothèses dentaires	47
2.6. Chariot de soins multisensoriel	48

03. Accessoires de parapharmacie **50**

Broyeur et coupe-comprimés de poche	51
Boîte à dentier	52
Piluliers journaliers et hebdomadaires	53

04. Gestion du linge et des déchets **54**

Chariots de distribution du linge	56
Chariots de change	58
Chariots support-sacs	60
Chariots à pince	62
Chariots de collecte du linge	63
Armoires de transport du linge	64
Chariots et rayonnage en fil chromé	65

05. Gestion du dossier patient **66**

Chariots de visite patients	67
Stations informatiques	68
Solutions d'informatisation des chariots	69

06. Circuit de la restauration **70**

07. Aides techniques pour le personnel **72**

Planches de transfert	73
Système de contention Pine!®	74

Who are we?

Qui sommes-nous ?

► French designer and manufacturer for over 30 years

Concepteur et fabricant français depuis plus de 30 ans



An « innovation » oriented company offering tailor-made solutions

Une entreprise orientée « innovation » proposant des solutions sur-mesure

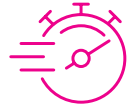

High reactivity: extremely short delivery times

Grande réactivité : délais de livraison extrêmement courts



More than 100 000 structures sold worldwide

Plus de 100 000 structures vendues dans le monde

PRATICIMA controls the entire products process through its design office and its 2 production sites based in France.

PRATICIMA maîtrise l'intégralité du process produits grâce à son bureau d'études et à ses 2 sites de production basés en France.



► An international presence

Une présence internationale

PRATICIMA is now present in more than fifty countries and responds to the needs of hospitals, clinics and elderly care.

PRATICIMA est aujourd'hui présent dans plus d'une cinquantaine de pays et répond aux besoins des établissements sanitaires et médico-sociaux.

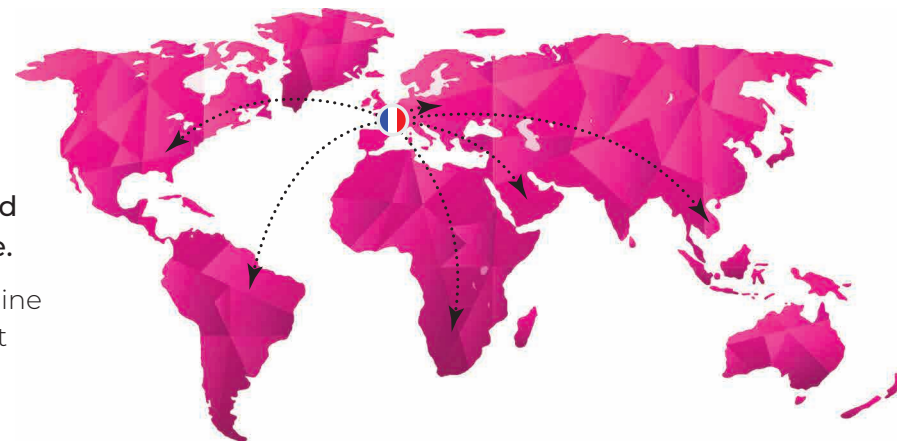

► A company committed to a CSR quality approach

Une entreprise engagée dans une démarche RSE



At the service of health Au service de la santé

Development of innovative products to reduce MSDs of the health professionals
Implementation of actions for risk prevention

Développement de produits innovants visant à réduire les TMS du personnel de santé

Mise en place d'actions pour la prévention des risques



At the service of quality Au service de la qualité

Commitment to develop the listening and the satisfaction of the customer: integrated management according to the international standards ISO 9001 version 2015

Engagement pour développer l'écoute et la satisfaction client : démarche de management intégré selon la norme internationale ISO 9001 version 2015

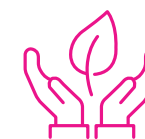

At the service of the environment Au service de l'environnement

Implementation of actions for mastering our ecological footprint through assessment and the control of impacts on the environment

Mise en place d'actions pour maîtriser notre empreinte écologique grâce à l'évaluation et le contrôle des impacts sur l'environnement

Neop

designed to cover all your needs
conçue pour couvrir tous vos besoins



PRATICIMA has developed a new range of trolleys and cabinets called Neop® that can handle all possible configurations for healthcare facilities. This range of products is designed for transport, storage and administration of medication and MD. They can also be equipped as nursing trolley or used in nurse stations.

PRATICIMA a développé Neop®, une gamme de chariots et d'armoires répondant à tous les besoins d'aménagement des établissements de santé. Cette gamme de produits est conçue pour le transport, le stockage, la distribution des médicaments et des DM, les soins et l'aménagement de salles de soins.

▶ A standard structure with many advantages

Une structure commune avec de nombreux atouts



Ergonomics / Ergonomique

- ▶ Top shelf and roller shutter door with grip area

Tablette supérieure et rideau avec zone de préhension ergonomique

Corrosion resistance

Résistance à la corrosion

- ▶ Monobloc box made of aluminium or steel according to models

Caisson monobloc en aluminium ou en acier selon les déclinaisons

Quality / Qualité

- ▶ Qualitative castors, to support heavy loads

Roues qualitatives supportant des charges lourdes

Modularity / Modularité

- ▶ Modular and compatible inside equipments for the different structures

Aménagements intérieurs modulables et compatibles avec les différentes structures

Safety / Sécurité

- ▶ Codelock, badge lock or badge lock with access control

Serrure à code, à badge ou à badge avec gestion d'accès

Hygiene / Hygiène

- ▶ Extractable roller shutter without tool, removable inside side panels, no retention zone

Rideau extractible sans outil, intercalaires démontables, aucune zone de rétention

Robustness / Robustesse

- ▶ Outside bumper for a complete structure protection

Pare-chocs débordant pour une protection complète de la structure



▶ A fully customizable range

Une gamme totalement personnalisable



▶ Different models of informatic holders available

Différents modèles de supports informatiques disponibles

▶ Upper frame with standard steel rails compatible with many accessories

Portique supérieur doté de rails normalisés en acier compatibles avec de nombreux accessoires

▶ Extension shelf to enlarge working surface

Tablette d'extension pour agrandir le plan de travail

▶ Ward name identification to keep furniture assignment

Marquage du nom du service pour conserver l'affectation du mobilier

▶ Many inside equipments available

Nombreux aménagements intérieurs disponibles

▶ 3 available colours

3 coloris au choix

■ Magenta pink / Rose magenta

■ Sky blue / Bleu céleste

■ Apple green / Vert pomme

▶ Removable lateral accessories to be fixed on steel standard lateral rail

Accessoires périphériques amovibles à positionner sur rail normalisé en acier

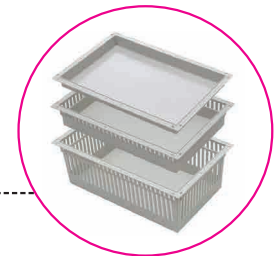
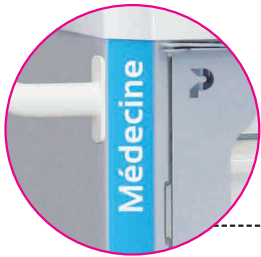

▶ A large selection of peripheral accessories

Un grand choix d'accessoires périphériques

Contact us for the full list of compatible accessories.

Consultez-nous pour connaître la liste complète des accessoires compatibles.



Storage box
Casier de rangement
→ Ref. 28063N.GR



Side basket
Panier fil
355 x 218 mm → Ref. 28062N.GR
405 x 218 mm → Ref. 28061N.GR



3-compartment document sorter
Trieur 3 cases
→ Ref. 28011N

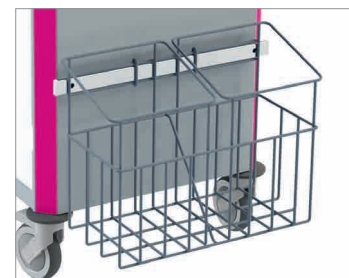

Waste bin holder
Support poubelle
Simple → Ref. 28071N.GR
Double → Ref. 28072N.GR



Universal holder for sharps disposal container
Support universel pour récupérateur à aiguilles
→ Ref. 28039



Ergonomic handle
Poignée ergonomique
→ Ref. 8Y005



Right handle
Poignée droite
→ Ref. 8F002



Foldable extension shelf
Tablette d'extension rabattable
→ Ref. 8Y008_0400

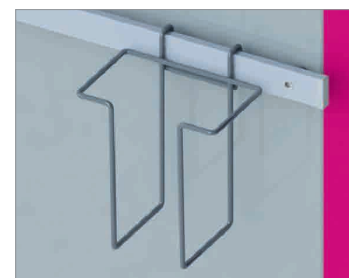

Standard bracket for gloves
Support pour boîte à gants
→ Ref. 28001N.GR

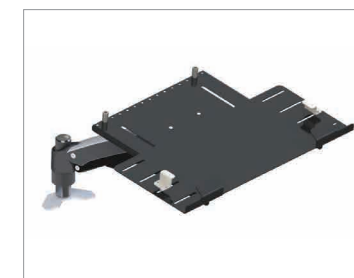

IT support
Support informatique
See page 69
Voir page 69

A person in a white lab coat is holding a tablet computer. The background shows shelves in a pharmacy or hospital setting, filled with various medication boxes and containers. The scene is brightly lit, and the focus is on the person's hands and the tablet.

01.

Medication management system

Circuit du médicament et des DM

STORAGE
Stockage en réserve



PREPARATION
Préparation



OVERALL OR PERSONAL DISPENSING
Délivrance globale ou nominative



ADMINISTRATION
Administration



PERSONAL TREATMENT STORAGE
Stockage traitement nominatif



TRANSPORT
Transport



1.1

Internal pharmacy equipment

Aménagement de PUI

Wire chromed shelves

Rayonnage en fil chromé



Mobile wire chromed shelving system on guides

Rayonnage en fil chromé mobile

The mobile wire chromed shelving system is an interesting solution to increase storage surface thanks to its sliding structure on rails.

Grâce à sa structure coulissante, le rayonnage mobile est une véritable solution pour augmenter les superficies de stockage.



► Light and resistant for heavy load

Léger et résistant aux lourdes charges

Fixed wire chromed shelving system

Rayonnage en fil chromé fixe

Fixed shelves can be straight-line or slotted angle assembled.

Le rayonnage fixe peut être monté linéairement ou en angle.

EasyDrawer® telescopic shelves

Rayonnage télescopique EasyDrawer®

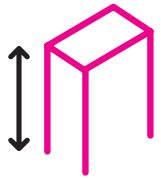

Height
Hauteur
2030 mm

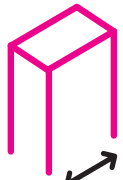

Length
Largeur
1000 mm



Depth
Profondeur
520 mm
930 mm

- ▶ Trays and telescopic drawers can be horizontally fitted or 15° tilted, for an improved visibility.

Pour une meilleure visibilité, les bacs et les tiroirs télescopiques peuvent être positionnés horizontalement ou inclinés à 15°.

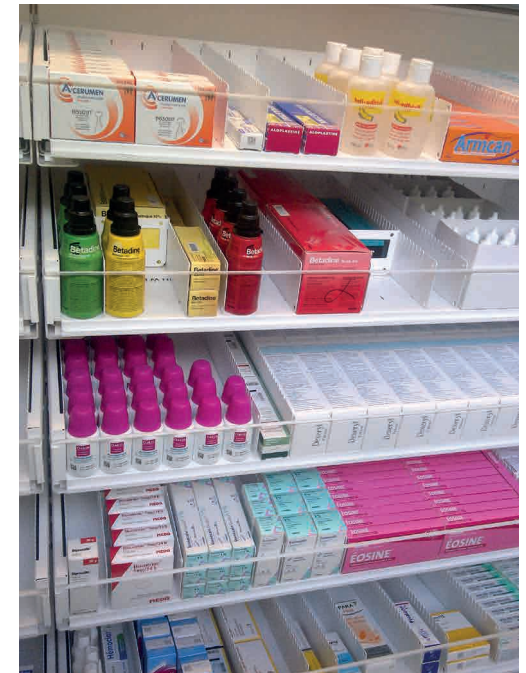

- ▶ This modular and self-supporting system is available in simple and double face.

Ce système modulaire et autoportant est disponible en simple et double face.

- ▶ Telescopic drawers can be locked in the open position for an easy medicine storage. Dividers optimise drawer's space depending on the products.

Les tiroirs télescopiques peuvent être verrouillés en position ouverte afin d'y ranger facilement les médicaments. Les séparations permettent d'optimiser l'espace des tiroirs en fonction des produits.

Opti Stock® stores

Rayonnage Opti Stock®

► The Opti Stock® range has been designed for back-up storage of sterile or non-sterile materials, which are either packed or unpacked. It is used in all wards, but particularly for cssd and operating theatre due to its unique features concerning hygiene.

La gamme Opti Stock® est conçue pour le stockage en réserves de matériel stérile ou non stérile, déconditionné ou non. Elle s'utilise dans tous les services, mais plus particulièrement pour le plateau technique de par ses qualités uniques dans le domaine de l'hygiène.

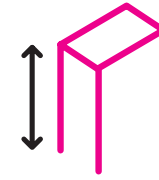

Height
Hauteur
1980 mm



Length / Largeur
400 - 600
1200 mm



Depth
Profondeur
400 - 600 mm



Fixed shelving system

Rayonnage fixe

Equipped with tilted shelves, fixed shelves and telescopic drawers
Équipé d'étagères inclinées, d'étagères fixes et de tiroirs télescopiques



Double mobile shelving system

Rayonnage mobile double

Equipped with 600 x 400 ISO trays
Équipé de bacs à lèbres 600 x 400

► **Compatible with all management methods: allocation, KanBan...**

S'adapte à tous les modes de gestion : dotation, plein / vide...

Opti Stock® supply trolley

Chariot d'approvisionnement Opti Stock®

400 x 600

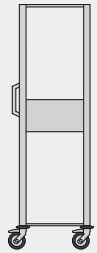

H. 160 simple

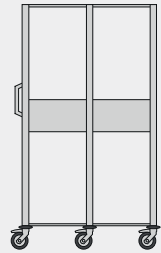

H. 160 double

600 x 400

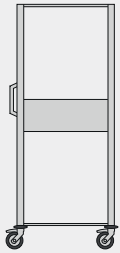

H. 160 simple

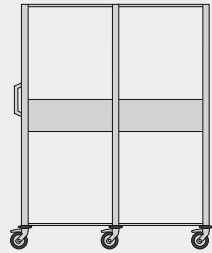

H. 160 double



600 x 400 single trolley
Chariot simple colonne 600 x 400
→ Ref. 8A761



600 x 400 ISO trays
Bac à lèvres 600 x 400

Height: 50, 100 or 200 mm
Dividers and label identification system in option
Hauteur : 50, 100 ou 200 mm
Peignes de compartimentage et identification en option

Picking station

Postes de cueillette

- ▶ Our picking stations are fully adaptable to the different layouts of treatment rooms. It is possible to add additional modules on each side of the main structure. The additional module is articulated which enables to get an ergonomic picking station.

Nos postes de cueillette sont totalement modulables et adaptables aux différents agencements de salles de soins. Il est possible d'ajouter un module secondaire de chaque côté du poste principal. Les modules secondaires sont articulés, permettant de créer un poste de cueillette ergonomique.



- ▶ Rails for different type of bins and drawers that may be positioned as needed

Rails où peuvent être positionnés des bacs à bec, des bacs-tiroirs et des tiroirs 600 x 400

- ▶ Work surface where 600 x 400 drawer or hanging storage units can be attached

Plan de travail où peut être fixé un tiroir 600 x 400 sur glissières ou un caisson suspendu



1.2

Solutions for storage

Solutions de stockage

Pharmacy cabinets

Armoires à pharmacie



Cabinet with 600 x 400 column
Armoire 1 colonne 600 x 400

L. 735 x D. 660 x H. 2000 mm
Closing with door and key lock

L. 735 x P. 660 x H. 2000 mm
Fermeture à porte avec serrure à clé
→ Ref. ARMOIRE_15



Cabinet with 400 x 400 and 600 x 400 compartment
Armoire avec compartiment 400 x 400 et 600 x 400

L. 1200 x D. 660 x H. 2000 mm
Closing with doors and key lock

L. 1200 x P. 660 x H. 2000 mm
Fermeture à portes avec serrure à clé
→ Ref. ARMOIRE_EX2



Cabinet for personal monthly storage
Armoire pour stockage mensuel nominatif

L. 1555 x D. 535 x H. 2000 mm
Curtain closure with key lock

L. 1555 x P. 535 x H. 2000 mm
Fermeture à rideau avec serrure à clé
→ Ref. 7A156

Neop[®] mobile storage cabinets

Armoires de stockage mobiles Neop[®]

- ▶ Code lock or badge lock, or without lock

Verrouillage par serrure à code ou à badge, ou sans verrouillage

- ▶ Roller shutter door or without closure

Fermeture à rideau ou sans fermeture

- ▶ Horizontal or tilted levels in upper position

Glissières horizontales ou inclinées en partie haute

- ▶ With bumpers or without bumpers

Avec ou sans pare-chocs

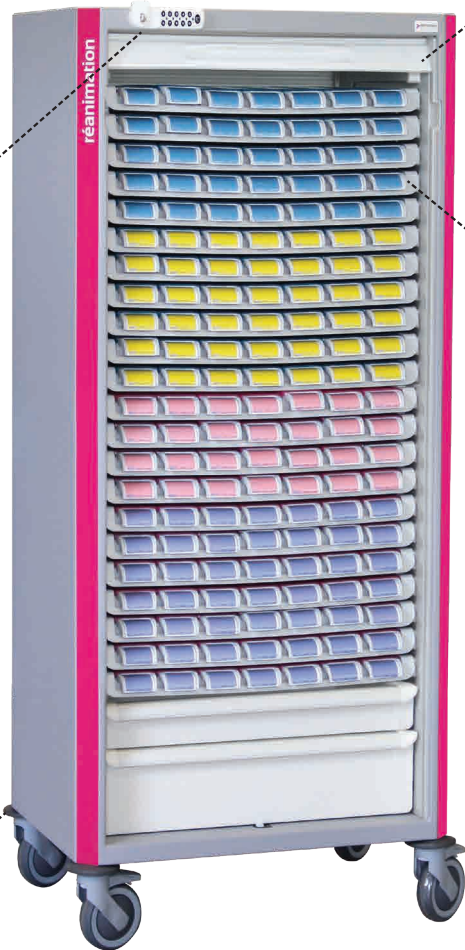

400 x 600



H. 160 simple

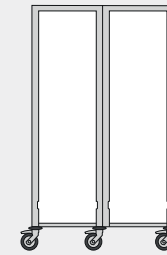

H. 160 double



H. 180 simple

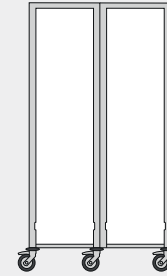

H. 180 double

600 x 400



H. 160 simple

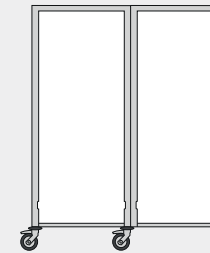

H. 160 double

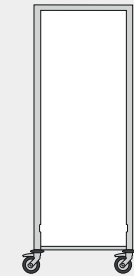

H. 180 simple

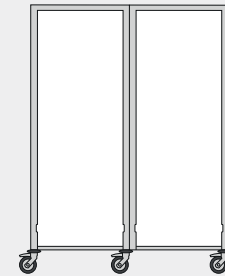

H. 180 double

600 x 400 H. 160 single cabinet

Armoire simple 600 x 400 H. 160

→ Ref. 8YAB164H160FRC_RM

► Designed for storage of medicines, solutes and medical devices

Conçu pour le stockage des médicaments, des solutés et des dispositifs médicaux



600 x 400 H. 180 double cabinet
Armoire double 600 x 400 H. 180
→ Ref. 8YAH264H180FRC_VP



400 x 600 H. 160 single cabinet
Armoire simple 400 x 600 H. 160
→ Ref. 8YAH246H160FRC_BC



400 x 600 H. 160 double cabinet
Armoire double 400 x 600 H. 160
→ Ref. 8YAH246H160FRC_BC

Storage cabinets and columns for pill dispenser trays

Armoires et colonnes de stockage pour piluliers

- ▶ Regarding the storage for Modulo® Classic and Modulo® XL pill dispenser trays, a wide product range of cabinets and columns are available. To ensure the logistic circuit from pharmacy to patient, these cabinets are fully compatible with the entire Modulo range. It is also possible to organize a weekly storage of your pill dispenser trays, as this system is adapted to the different sizes of establishments and their organizations.

Pour le stockage des piluliers Modulo® Classic et Modulo® XL, une large gamme d'armoires et de colonnes est disponible. Celles-ci s'inscrivent dans une gamme complète pour assurer le circuit logistique du médicament depuis la pharmacie jusqu'au patient. Adaptées aux différentes tailles d'établissements et aux différentes organisations, elles permettent un stockage hebdomadaire des piluliers.

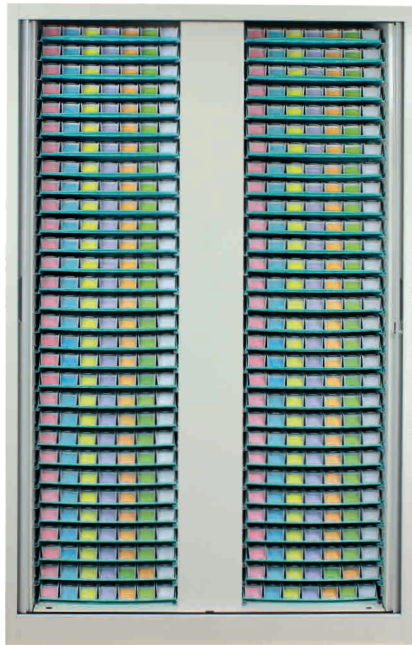

Modulo® Classic cabinet with curtain doors
Armoire fixe à rideau Modulo® Classic

Capacity: 30, 60 or 90 pill dispenser trays
Capacité : 30, 60 ou 90 plateaux de piluliers



Modulo® Classic open mobile column
Colonne mobile ouverte Modulo® Classic

Capacity: 26 or 52 pill dispenser trays
Capacité : 52 plateaux de piluliers



Modulo® XL 600 x 400 open mobile column
Colonne mobile ouverte 600 x 400 Modulo® XL

Capacity: 32 pill dispenser trays
Capacité : 32 plateaux de piluliers
→ Ref. 8F5432

1.3

Solutions for transfer

Solutions de transfert

Transfer cabinets

Armoires de transfert



Modulo® Classic transfer cabinet
Armoire de transfert Modulo® Classic

Capacity: 28, 40 or 50 pill dispenser trays
Height: 1270, 1610 or 1920 mm

Capacité : 28, 40 ou 50 plateaux de piluliers
Hauteur : 1270, 1610 ou 1920 mm

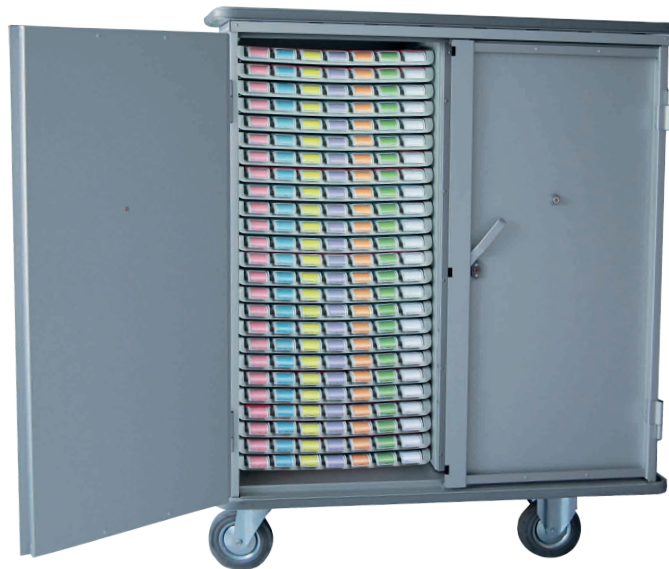

Transfer cabinet for 600 x 400 pill dispenser trays
Armoire de transfert pour piluliers 600 x 400

Available in single and double columns
Height: 900, 1160 or 1400 mm

Disponible en simple et double colonne
Hauteur : 900, 1160 ou 1400 mm



Transfer cabinet for 600 x 400 trays and drawers
Armoire de transfert pour bacs logistiques 600 x 400

Available in single, double and triple columns
Height: 900, 1160 or 1400 mm

Disponible en simple, double et triple colonne
Hauteur : 900, 1160 ou 1400 mm

Neop[®] transfer trolleys and cabinets

Chariots et armoires de transfert Neop[®]

▶ Code lock or badge lock

*Verrouillage par serrure
à code ou à badge*

▶ Roller shutter door

Fermeture à rideau

▶ Possible binding for transport at all levels, on the external framework

*Sanglage camion possible
à tous niveaux, à l'extérieur
de l'armature de transfert*

▶ With 2 or 4 swivelling wheels with brake

*Avec 2 ou 4 roues
pivotantes à frein*



600 x 400

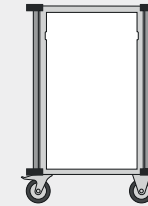

H. 120
simple

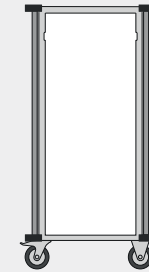

H. 160
simple

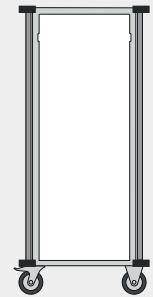

H. 180
simple

600 x 400 H. 160 transfer cabinet

Armoire de transfert 600 x 400 H. 160

→ Ref. 8YATR164H160_RM_V2

► **Designed for supply of medicines and medical devices**

Conçu pour l'approvisionnement des médicaments et des dispositifs médicaux



600 x 400 H. 180 transfer cabinet
Armoire de transfert 600 x 400 H. 180
→ Ref. 8YATR164H180_RM_V2



600 x 400 H. 120 transfer trolley
Chariot de transfert 600 x 400 H. 120
→ Ref. 8Y164H120P4.TR_V2

EasyMove⁺

► **MOTORISATION of transfer trolleys and cabinets to help you limit MSDs and improve the comfort for healthcare professionals**

Solution de MOTORISATION pour chariots et armoires de transfert permettant de limiter les TMS et d'améliorer le CONFORT de travail du personnel soignant



Trolleys and pharmacy box for transport

Chariots et bacs de transport



Wire chromed trolley
Chariot en fil chromé

Fully customizable
Different dimensions and many available accessories
*Totalement personnalisable
Différentes dimensions et nombreux accessoires disponibles*



Fabric cover for wire chromed trolley
Housse pour chariot en fil chromé

Adaptable for trolleys without push handle bar
Adaptable uniquement sur les chariots sans poignée



Folding transfer trolley
Chariot de transfert pliant

Maximum load: 150 kg
Dim. unfolded: L. 740 x D. 450 x H. 870 mm
Dim. folded: L. 530 x D. 450 x H. 240 mm
*Charge maximale : 150 kg
Dim. déplié : L. 740 x P. 450 x H. 870 mm
Dim. plié : L. 530 x P. 450 x H. 240 mm*
→ Ref. BI2001



Security seal
Scellé de sécurité

Batch of 100 seals with numbers
Lot de 100 scellés numérotés
→ Ref. SCELLES_4



Pili® box pharmacy container
Boîte de transport Pili® box

L. 475 x D. 352 x H. 315 mm
Batch of 5 boxes locked with security seal
L. 475 x P. 352 x H. 315 mm
Lot de 5 boîtes fermées par lien de sécurité
→ Ref. 5E009

1.4

Solutions for medicine distribution

Solutions de distribution du médicament

Trolleys for medium stay and long stay

Chariots pour le moyen et le long séjour



Pili® Cart trolley
Chariot Pili® Cart

Capacity: 10, 12, 20 or 24 Modulo® Classic pill dispenser trays
Curtain door and code lock
Equipped of 1 handle and 4 standard rails

Capacité : 10, 12, 20 ou 24 piluliers Modulo® Classic
Fermeture par rideau coulissant et serrure à code
Équipé d'une poignée et de 4 rails standards

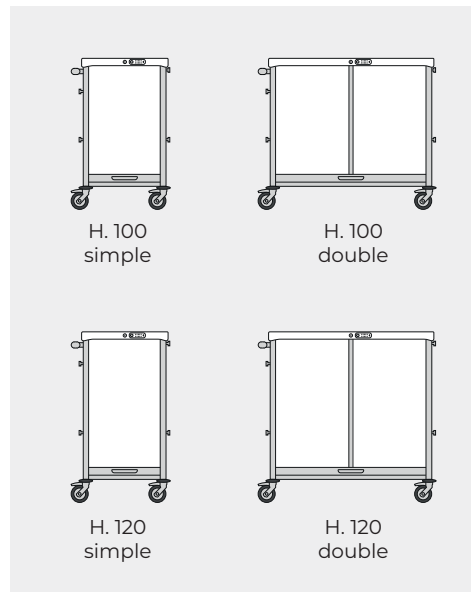

Modulo® Classic distribution system
Système Modulo® Classic

410 x 340 tray with 7 daily pill dispensers equipped with 4 dividers and a lid
Suitable for the use of dry and drinkable forms

Plateau 410 x 340 avec 7 piluliers journaliers équipés de 4 curseurs et d'un couvercle
Adapté à l'usage des formes sèches et buvables

■ → Ref. 52100

■ → Ref. 52200



Hebdo® trolley
Chariot Hebdo®

Capacity: 30 or 60 Hebdo® pill dispensers
Curtain door and code lock
Equipped of 1 handle and 4 standard rails
Capacité : 30 ou 60 piluliers Hebdo®
Fermeture par rideau coulissant et serrure à code
Équipé d'une poignée et de 4 rails standards



Pil® 7 trolley
Chariot Pil® 7

Capacity: 30 Pil® 7 pill dispensers
Curtain door and code lock
Equipped of 1 handle and 4 standard rails
Capacité : 30 piluliers Pil® 7
Fermeture par rideau coulissant et serrure à code
Équipé d'une poignée et de 4 rails standards
→ Ref. 8D030_PIL7_CODE

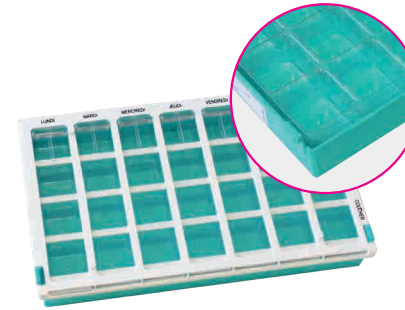

Hebdo® pill dispenser
with fixed dividers
Pilulier Hebdo® à cases fixes

L. 319 x D. 199 x H. 42 mm
L. 319 x P. 199 x H. 42 mm
→ Ref. 505001BL

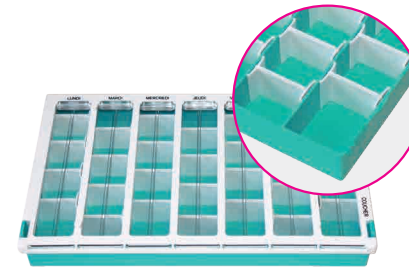

Hebdo® pill dispenser
with removable dividers
Pilulier Hebdo® à cases réglables

L. 319 x D. 199 x H. 42 mm
L. 319 x P. 199 x H. 42 mm
→ Ref. 50610

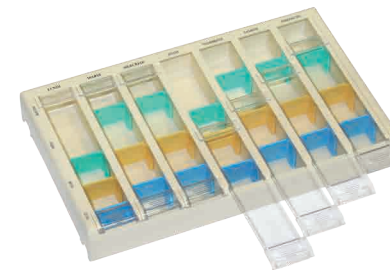

Pil 7® pill dispenser
Pilulier Pil 7®

L. 320 x D. 200 x H. 40 mm
Pill dispenser with removable dividers
Batch of 5 pieces
L. 320 x P. 200 x H. 40 mm
Pilulier à cases réglables
Lot de 5 pièces
→ Ref. CD23616

Neop® distribution trolleys

Chariots de distribution Neop®

- ▶ Thermoplastic upper shelf with ergonomic gripping area or compact laminate upper shelf

Tablette supérieure en thermoplastique avec zone de préhension ergonomique ou tablette en stratifié compact

- ▶ Code lock or badge lock

Verrouillage par serrure à code ou à badge



- ▶ Roller shutter door or door wing for telescopic drawers

Fermeture à rideau ou battant pour tiroirs télescopiques

400 x 400

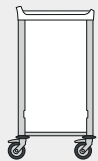

H. 100 simple

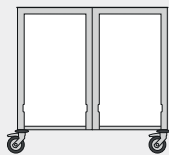

H. 100 double

600 x 400

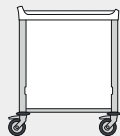

H. 80 simple

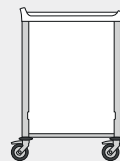

H. 100 simple

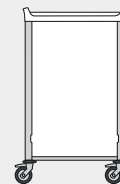

H. 120 simple

EasyMove

- ▶ **MOTORISATION** of the trolleys to help you limit MSDs and improve the comfort for healthcare professionals

Solution de MOTORISATION des chariots permettant de limiter les TMS et d'améliorer le CONFORT de travail du personnel soignant



Available option on trolleys 600 x 400 H. 100 and H. 120

Option disponible sur les chariots 600 x 400 H. 100 et H. 120

► **Designed for weekly medicine preparation with daily pill dispenser trays**

Conçu pour la dispensation hebdomadaire des médicaments avec des piluliers journaliers



600 x 400 H. 80 distribution trolley
Chariot de distribution 600 x 400 H. 80
→ Ref. 8Y164H80P4



600 x 400 H. 100 distribution trolley
Chariot de distribution 600 x 400 H. 100
→ Ref. 8YCHM164H100RCT_RM



600 x 400 H. 120 simple trolley
Chariot simple 600 x 400 H. 120
→ Ref. 8YCHM164H120RCT_RM

▶ Detachable daily pill dispensers integrated on a tray

Piluliers détachables mais solidaires du plateau



Modulo® XL distribution system
Système Modulo® XL

600 x 400 tray with 7 daily dispensers equipped with 4 dividers and 1 lid

Plateau 600 x 400 avec 7 piluliers journaliers équipés de 4 curseurs et d'un couvercle

■ → Ref. 5AP040BL

■ → Ref. 5AP040FR

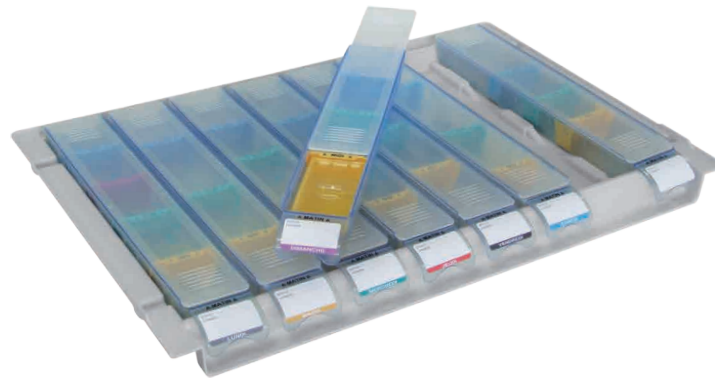

Eurojour® distribution system
Système Eurojour®

600 x 400 tray with 8 daily dispensers equipped with 3 dividers and 1 lid

Plateau 600 x 400 avec 8 piluliers journaliers équipés de 3 curseurs et d'un couvercle

→ Ref. CP23606.72

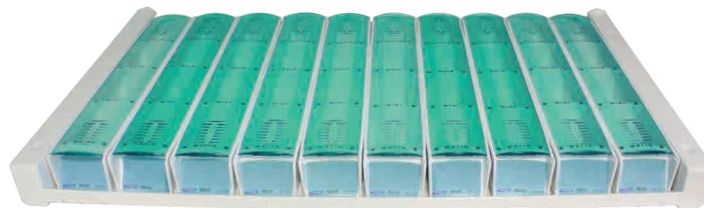

Modulo® Classic distribution system
Système Modulo® Classic

600 x 400 tray with 10 daily dispensers equipped with 4 dividers and 1 blue lid

Plateau 600 x 400 avec 10 piluliers journaliers équipés de 4 curseurs et d'un couvercle bleu

→ Ref. 8AP010BL

► **Designed for daily medicine preparation with storage bins**

Conçu pour la dispensation journalière des médicaments avec des bacs nominatifs



400 x 400 H. 100 distribution trolley
Chariot de distribution 400 x 400 H. 100
→ Ref. 8Y144H100P4



600 x 400 H. 100 distribution trolley
Chariot de distribution 600 x 400 H. 100
→ Ref. 8YM64H100DI24E1



600 x 400 H. 120 simple trolley
Chariot simple 600 x 400 H. 120
→ Ref. 8Y164H120P4.TR

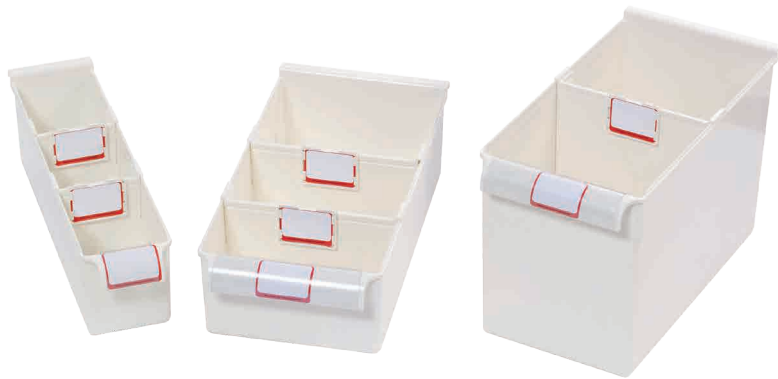

Bins
Bacs-tiroirs

Height: 70 - 110 - 150 or 230 mm
 Wide: 1/6 - 1/4 or 1/3
 Hauteur : 70 - 110 - 150 ou 230 mm
 Largeur : 1/6 - 1/4 ou 1/3



► Made for single bag roll distribution

Conçu pour la distribution des rouleaux sachets doses



Bins for medication rolls
Bacs-tiroirs dévidoirs

Height: 70 or 110 mm
 Wide: 1/6
 Hauteur : 70 or 110 mm
 Largeur : 1/6



► Partition by compartment kit or by bins

Cloisonnement par kit de compartimentage ou par bacs-tiroirs



600 x 400 drawer
Tiroir 600 x 400

Height: 75 - 115 - 155 or 235 mm
 Hauteur : 75 - 115 - 155 ou 235 mm

400 x 400 drawer
Tiroir 400 x 400

Height: 75 - 115 - 155 or 235 mm
 Hauteur : 75 - 115 - 155 ou 235 mm

► **Designed for medicine preparation with ISO trays**

Conçu pour la dispensation des médicaments avec des bacs à lèvres



600 x 400 H. 100 distribution trolley with telescopic drawers

Chariot de distribution 600 x 400 H. 100 avec tiroirs télescopiques

→ Ref. 8Y164H100T



400 x 400 H. 100 distribution trolley with telescopic drawers

Chariot de distribution 400 x 400 H. 100 avec tiroirs télescopiques

→ Ref. 8Y144H100T

► **Removable ISO tray**

Bac à lèvres amovible

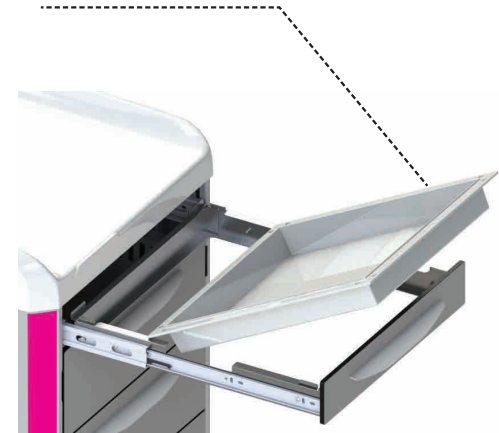

► **Partition by compartment kit or by bins**

Cloisonnement par kit de compartimentage ou par bacs de subdivision

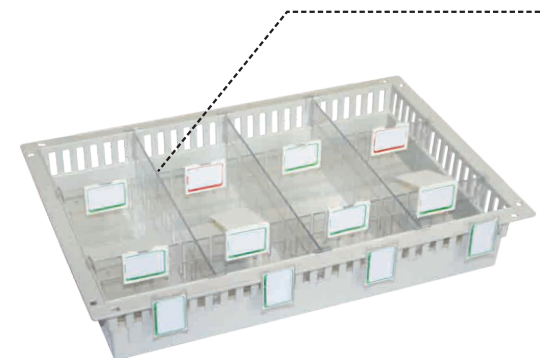

1.5

Solutions for medicine preparation

Solutions pour la préparation des médicaments

- In order to facilitate medication intake, medical staff must regularly crush the pills for the patients who have swallowing disorders. PRATICIMA offers you a manual and electric solution. These crushers developed in collaboration with health professionals prevent musculoskeletal disorders and cross-contamination.

Afin de faciliter la prise de médicaments, le personnel soignant doit régulièrement broyer les comprimés des patients ayant des troubles de la déglutition. PRATICIMA vous propose une solution manuelle et électrique. Ces broyeurs développés en collaboration avec des professionnels de santé évitent les troubles musculo-squelettiques et les contaminations croisées.



Tookan® manual pill crusher
Écrase comprimés manuel Tookan®

→ Ref. NA00017_V02

1000 universal bags for pill crusher
1000 sachets universels pour écrase-comprimé

Dimensions: L. 50 x H. 100 mm

Dimensions : L. 50 x H. 100 mm

→ Ref. NA00011.01



Severo® electrical pill crusher
Broyeur de comprimés électrique Severo®

→ Ref. NA00030.01

2100 single use cups
2100 gobelets à usage unique

→ Ref. NA00014.01

2000 single use lids for cups
2000 couvercles à usage unique

→ Ref. NA00015.01

2100 washers single-use Cellophane
2100 rondelles cellophane à usage unique

→ Ref. NA00016



Pili® Blade cutting tool
Outil de découpe Pili® Blade

Cuts all types of blisters and bags
Effortless Natural Movement
Limits MSDs
Secured blade and non-accessible
Découpe tous types de plaquettes et de sachets
Mouvement naturel sans effort
Limite les TMS
Lame sécurisée non accessible
→ Ref. 5H001



02.

Care management and equipment

Mobilier de soins et équipements de service

DEPARTMENTS
Services



CORRIDOR
Couloir



ROOMS
Chambres



2.1

Nurse station equipment

Aménagement de salles de soins

Neop® modular nurse stations

Salles de soins modulaires Neop®

- ▶ Neop® range enables to satisfy the needs of most demanding customers concerning hygiene and facilitates nurse station reorganization. It offers fixed or mobile and 600 x 400 or 400 x 600 compatible furniture. The one-piece structures with telescopic drawers or roller shutter are made of corrosion resistant treated steel. The work surfaces can be fixed, wall-mounted or mobile.

La gamme Neop® permet de répondre aux besoins les plus exigeants en matière d'hygiène et facilite la réorganisation de la salle. Elle se compose de mobilier fixe ou mobile compatible 600 x 400 ou 400 x 600. Les caissons monoblocs, à tiroirs ou à rideau, sont en acier traité anticorrosion. Les plans de travail peuvent être fixes, suspendus ou mobiles.

- ▶ Acrylic resin or compact laminated work surface with or without sink

Paillasse sèche ou humide, en résine acrylique ou en stratifié compact

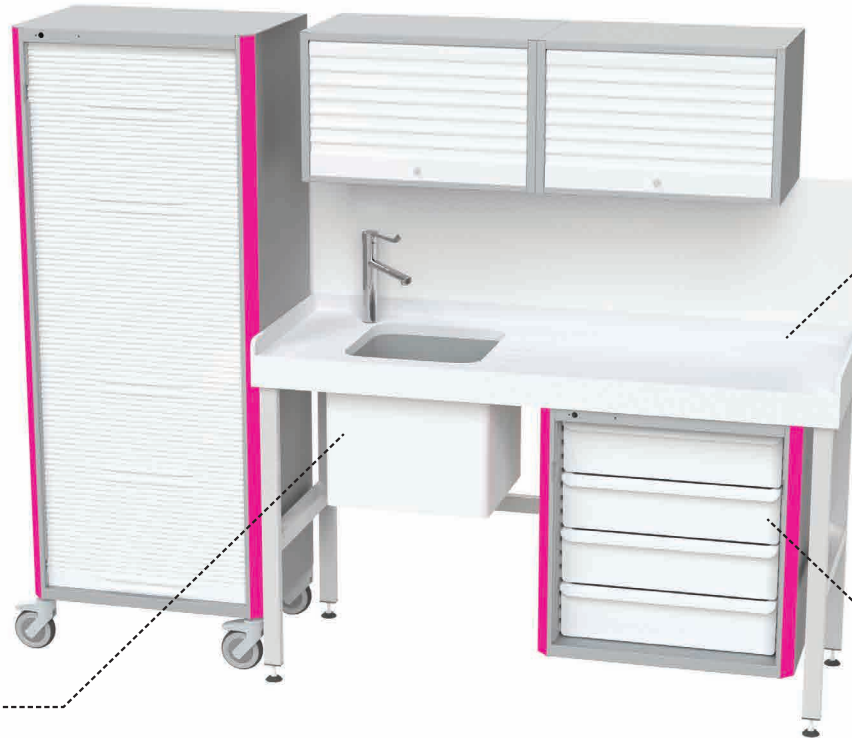

- ▶ Fixed, mobile or hanging, double or triple work surface

Plan de travail double ou triple, fixe, mobile ou suspendu

- ▶ 600 x 400 or 400 x 600 hanging structure, with or without curtain door

Caisson suspendu 600 x 400 ou 400 x 600, avec ou sans rideau



600 x 400 mobile work surface with 2 columns
 Plan de travail mobile 2 colonnes 600 x 400
 → Ref. 8YPTM264H100TJ_RM



Mobile double tubular work surface with 600 x 400 H. 80 mobile structure
 Plan de travail tubulaire mobile double avec caisson mobile 600 x 400 H. 80



Tubular fixed work surface and 400 x 600 hanging structures
 Plan de travail tubulaire fixe avec caissons suspendus 400 x 600



Neop® wall cupboard
 Placard mural Neop®
 → Ref. 8Y164.MU

Nurse station with furniture with laminated fronts

Salles de soins menuisées



- ▶ Our furniture are designed to receive any kind of equipments (trays, drawers, pill dispensers,...) which are also used for our whole storage and distribution ranges (trolleys, cabinets...) with 600 x 400, 400 x 600 and 400 x 400 standards. The furniture are made of laminated panels and are based on adjustable cylinders with hanging support for skirting boards.

Notre mobilier menuisé est conçu pour accueillir les équipements (bacs, tiroirs, piluliers...) également utilisés dans l'ensemble des gammes de stockage et de distribution (chariots, armoires...) à la norme 600 x 400, 400 x 600 et 400 x 400. Les meubles sont réalisés en panneaux de particules mélaminés et reposent sur des vérins réglables avec support d'accroche pour plinthes.

2.2

Dressing trolleys

Chariots et guéridons de soins

Neop® dressing trolleys

Chariots de soins Neop®

- ▶ Door wing for telescopic drawers or roller shutter door for joint drawers

Fermeture à battant pour tiroirs télescopiques ou à rideau pour tiroirs jointifs

- ▶ Code lock or badge lock

Verrouillage par serrure à code ou à badge



- ▶ Compact laminate upper shelf or thermoplastic upper shelf with ergonomic gripping area

Tablette supérieure en stratifié compact ou en thermoplastique avec zone de préhension ergonomique

400 x 400



H. 100 simple

600 x 400

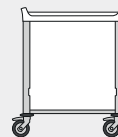

H. 80 simple



H. 100 simple

EasyMove

- ▶ **MOTORISATION of the trolleys to help you limit MSDs and improve the comfort for healthcare professionals**

Solution de MOTORISATION des chariots permettant de limiter les TMS et d'améliorer le CONFORT de travail du personnel soignant



Available option on trolleys
600 x 400 H. 100

*Option disponible sur les chariots
600 x 400 H. 100*



**600 x 400 H. 100 dressing trolley
with joint drawers**
Chariot de soins 600 x 400 H. 100
avec tiroirs jointifs
→ Ref. 8YS64H100TJ1_BC



**400 x 400 H. 100 dressing trolley
with telescopic drawers**
Chariot de soins 400 x 400 H. 100
avec tiroirs télescopiques
→ Ref. 8YS44H100TT2_RM



600 x 400 H. 100 plaster trolley
Chariot à plâtre 600 x 400 H. 100
→ Ref. 8Y164H100T.PL

Upperframe with jersey roll support
Portique avec distributeur de jersey tubulaire
→ Ref. 8Y012

Agily® dressing trolleys

Guéridons de soins Agily®

- ▶ The Agily® trolleys are customizable and can be adapted for different uses. They can be equipped with drawers, additional shelves, an upper frame as well as many lateral accessories.

Les guéridons Agily® sont totalement personnalisables et évolutifs. Ils peuvent être équipés de tiroirs, de tablettes supplémentaires, d'un portique supérieur ainsi que de nombreux accessoires périphériques.



400 x 400 dressing trolley with thermoplastic shelves

Guéridon de soins 400 x 400
avec tablettes en thermoplastique

→ Ref. AGIL4_20



600 x 400 dressing trolley with thermoplastic shelves

Guéridon de soins 600 x 400
avec tablettes en thermoplastique

→ Ref. AGIL6_10

▶ Available colours

Coloris disponibles



600 x 400 dressing trolley with compact laminated shelves

Guéridon de soins 600 x 400
avec tablettes en statifié compact

→ Ref. AGIL6_13

Resine® dressing trolleys

Guéridons de soins Résine®

▶ Large range of accessories
Nombreux accessoires compatibles



400 x 400 dressing trolley
Guéridon de soins 400 x 400
→ Ref. FA44203.XX

▶ Available colours
Coloris disponibles



600 x 400 dressing trolley
Guéridon de soins 600 x 400
→ Ref. FA64301.XX

400 x 400



2 shelves + 1 drawer
2 plateaux + 1 tiroir



2 shelves + 2 drawers
2 plateaux + 2 tiroirs



2 shelves + 3 drawers
2 plateaux + 3 tiroirs



3 shelves
3 plateaux



3 shelves + 1 drawer
3 plateaux + 1 tiroir

600 x 400

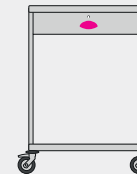

2 shelves + 1 drawer
2 plateaux + 1 tiroir

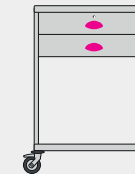

2 shelves + 2 drawers
2 plateaux + 2 tiroirs

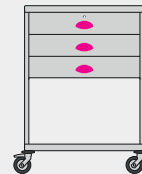

2 shelves + 3 drawers
2 plateaux + 3 tiroirs

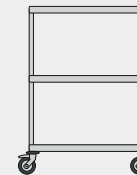

3 shelves
3 plateaux

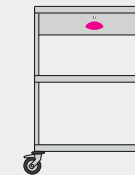

3 shelves + 1 drawer
3 plateaux + 1 tiroir

2.3

Emergency trolleys

Chariots d'urgence

- Our crash carts enable an immediate use of all necessary items for emergency. On all our trolleys, the drawers are locked with a single use seal with numbers. In order to have access to the drawers, you need to brake the seal. After using the trolley, you need to refill it and put a new seal with numbers.

Nos chariots d'urgence assurent une disponibilité immédiate du matériel et des produits nécessaires aux interventions de première urgence et ce, en toute sécurité. Sur tous nos modèles de chariots, les tiroirs sont condamnés par une fermeture par scellé. Pour avoir accès au contenu du chariot, il suffit de rompre le scellé à usage unique. Après chaque utilisation, le chariot est rééquipé, puis condamné par un nouveau scellé numéroté.



Neop® 400 x 400 emergency trolley equipped with 5 telescopic drawers
 Chariot d'urgence 400 x 400 Neop®
 équipé de 5 tiroirs télescopiques

→ Ref. 8Y144H100T.U2



Neop® 600 x 400 emergency trolley equipped with 5 telescopic drawers
 Chariot d'urgence 600 x 400 Neop®
 équipé de 5 tiroirs télescopiques

→ Ref. 8Y164H100T.U2



Neop® 600 x 400 emergency trolley equipped with 5 joint drawers
 Chariot d'urgence 600 x 400 Neop®
 équipé de 5 tiroirs jointifs

→ Ref. 8Y164H100P4.U2

2.4

Equipment for operating theatre

Équipement pour le bloc opératoire



**Neop® 600 x 400 H. 80
mobile structure**

Caisson mobile 600 x 400
H. 80 Neop®

→ Ref. 8YCAM164H80TJ_BC



**Neop® 600 x 400 H. 100
anaesthesia trolley**

Chariot d'anesthésie
600 x 400 H. 100 Neop®

→ Ref. 8YCHANS164H100_RM



**Neop® 600 x 400 double mobile
work surface**

Plan de travail mobile double
600 x 400 Neop®

→ Ref. 8Y264H100P4_PM



Neop® 600 x 400 catheter cabinet H. 180

Armoire à sondes Neop® 600 x 400 H. 180

→ Ref. 8YAH164H180SDE_RM



Clamp collection trolley
Collecteur à pinces

Bag holder with pedal
Hermetic clamp
18/10° stainless steel structure
*Collecteur à pédale
Fermeture hermétique
En acier inoxydable 18/10°
70-120 L → Ref. AB11080
40-80 L → Ref. AB11082*



Double face hook trolley
Chariot patères double face

Dimensions: 630 x 750 x 1590 mm
Unique patented system with adjustable hooks every 110 mm
Increases the loading capacity of accessories on the trolley
*Dimensions : 630 x 750 x 1590 mm
Montants profilés avec crochets réglables tous les 110 mm
Système permettant d'optimiser le nombre d'accessoires sur le chariot
→ Ref. HB11002*



Bowl holder
Porte-cupules

Stainless steel column and bowl holder
Stainless steel bowl Ø 260 mm
Base with 5 aluminium feet
5 castors Ø 50 mm
*Colonne et support en acier inoxydable
Cupules Ø 260 mm
Piètement 5 branches aluminium
5 roulettes doubles galets Ø 50 mm
→ Ref. HF01028*



Kick bucket
Bacquet roulant

Stainless steel bucket holder
Height: 180 mm
Capacity: 14 litres
Ø 350 mm
*Support en acier inoxydable
Hauteur : 180 mm
Contenance : 14 litres
Ø 350 mm
→ Ref. HF01030*



Instrument table
Table pont

Entirely made of stainless steel
Superior flat tray: 900 x 600 mm
Height adjustable from 900 to 1500 mm
Antistatic castors Ø 75 mm, 2 with brake

Structure en acier inoxydable
Plateau plat : 900 x 600 mm
Hauteur réglable : 900 à 1500 mm
Roulettes antistatiques Ø 75 mm

→ Ref. HF11070



Mayo instrument tray
Assistant muet

Frame entirely made of stainless steel
Upper tray: 600 x 400 mm
Height adjustable from 960 to 1500 mm
Antistatic castors Ø 75 mm, 2 with brake

Structure en acier inoxydable
Dimensions du plateau : 600 x 400 mm
Hauteur réglable : 960 à 1500 mm
Roulettes antistatiques Ø 75 mm dont 2 à frein

Hydraulic tray
Plateau embouti
→ Ref. HF81047

Flat tray
Plateau plat
→ Ref. HF01031



IV stand
Pied porte-sérum

Stainless steel frame
4 plastic hooks
Height adjustment: 1100 to 2000 mm
500 mm base width
Mobile plastic base
5 wheels Ø 50 mm

Fourreau et tige en acier inoxydable
4 crochets plastique
Hauteur réglable : 1100 à 2000 mm
Encombrement au sol : 500 mm
Piètement 5 branches en plastique
5 roulettes jumelées Ø 50 mm

2.5

Dental prosthesis cleaning system

Système de nettoyage pour prothèses dentaires



C2S® PRO cleaning system
Système de nettoyage C2S® PRO

Through dynamic brushing with special alloy bristles, the C2S® PRO system allows the daily and restorative cleaning of all types of removable and screw-retained dentures.
Dim. : L. 200 x D. 175 x H. 195 mm

Par brossage dynamique avec des aiguillettes d'alliage spécial, la C2S® PRO permet le nettoyage quotidien et curatif de tous types de prothèses dentaires amovibles et transvissées.

Dim. : L. 200 x P. 175 x H. 195 mm
→ Ref. 2CPRO



Personalised bowl
Bol personnalisé

Its use avoids cross contamination.
Batch of 2 bowls

*Son utilisation évite les contaminations croisées.
Lot de 2 bols*

→ Ref. 2CBOLRM



Dental care trolley
Chariot dental care

It optimizes the efficiency and quality of all dental care in health facilities.

Dim. : L. 615 x D. 468 x H. 988 mm
Rolling shutter and lock

Ce chariot optimise l'efficacité et la qualité de tous les soins bucco-dentaires dans les établissements de santé.

Dim. : L. 615 x P. 468 x H. 988 mm
Fermeture par rideau coulissant
Serrure à code

→ Ref. 8Y144.DT



C2S® TAB bicarbonate tablets
Comprimés de bicarbonate C2S® TAB

This effervescent sodium bicarbonate tablets are used daily with the C2S Pro cleaning system. Their active ingredients act as antibacterial and descaling agents.
Box of 200 thyme-mint fragrance tablets

*Ces comprimés effervescents ont un pouvoir antibactérien et détartrant. Ils sont à utiliser quotidiennement.
Boîte de 200 comprimés arôme menthe thym*

→ Ref. 2CTAB

2.6

Multisensory nursing trolley

Chariot de soins multisensoriel

- ▶ Satellite® multisensory nursing trolley offers non-drug therapy as a complement to the healthcare pathway. Satellite® is dedicated to the gerontology and disability sectors and was designed in collaboration with doctors, occupational therapists, and psychomotricity specialists. This trolley allows to provide the multi-sensory care based on hearing, sight, smell, and touch.

Le chariot de soins multisensoriel Satellite® offre une thérapie non médicamenteuse en complément du parcours de soins. Dédié aux secteurs de la gérontologie et du handicap, Satellite® a été conçu en collaboration avec des médecins, des ergothérapeutes et des psychomotriciens. Ce chariot permet de délivrer des soins multisensoriels basés sur l'ouïe, la vue, l'odorat et le toucher.

- ▶ Adjustable spotlight for video broadcasting on wall or ceiling

Projecteur orientable pour une diffusion de vidéos au mur ou au plafond

SATELLITE®

- ▶ Musical speakers

Enceintes musicales

- ▶ Essential oil diffuser: different fragrances

Diffuseurs d'huiles essentielles: 6 senteurs différentes

- ▶ Fiber optic cables, with colour changes, located at optimal height for people in bed or in (wheel) chair

Fibres optiques, qui changent de couleur, placées à hauteur optimale pour personne alitée ou en fauteuil

- ▶ Water bubble panel

Mur de bulles d'eau

- ▶ Storage drawers of small materials: light balls, hedgehog balls, heating pad...

Tiroirs dédiés au stockage du petit matériel : balles lumineuses, balles hérisson, coussin chauffant...

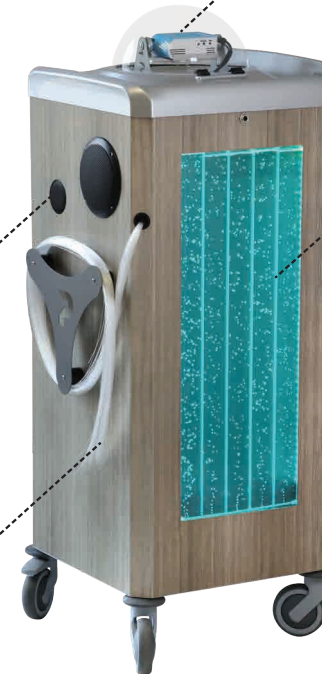

▶ Video

► Deploy the Snoezelen concept with Satellite® trolley

Déployez le concept Snoezelen avec le chariot Satellite®



A cart which combines all kind of multi-sensory elements

Un chariot combinant tous les éléments multisensoriels



A mobile solution which doesn't need any dedicated room, ideal for facilities in search of space saving

Une solution mobile ne nécessitant pas de salle dédiée, idéal pour les établissements en recherche de gain de place



Usable in any facility including wet environment: bathroom or balneotherapy

Utilisable dans tout l'établissement y compris en milieu humide : salle de bain ou de balnéothérapie

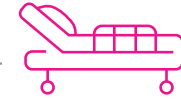

Adapted to people who have difficulty moving: bedridden or in (wheel) chair

Adapté aux personnes ayant des difficultés à se déplacer : alitées ou en fauteuil

► An easy-to-use ergonomic trolley

Un chariot ergonomique et simple d'utilisation

6 pre-set care programmes + 1 free atmosphere

6 programmes de soins prédéfinis + 1 ambiance libre



Stimulating
Stimulant



Balneo
Balnéo



Before meal
Avant-repas



Soothing
Apaisant



Relaxing
Reposant



Night
Nuit

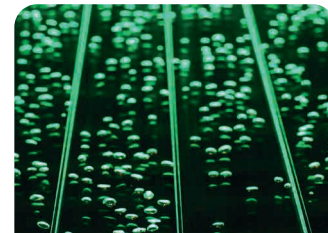



03.

Pharmacy accessories

Accessoires de parapharmacie

Pocket pill cutter and crusher

Broyeur et coupe-comprimés de poche



Pill splitter

Broyeur de comprimés

Helps to take medicines more easily

Storage area

Dim. : L. 50 x D. 50 x H. 45 mm

Batch of 5 pieces

Facilite la prise des médicaments

Compartiment de réserve

Dim. : L. 50 x P. 50 x H. 45 mm

Lot de 5 pièces

→ Ref. NA03318



Pill crusher

Coupeur de comprimés

Easily divides pills

Stainless steel blade

Storage area

Dim. : L. 85 x D. 33 x H. 26 mm

Batch of 5 pieces

Coupe en deux les comprimés

Lame en acier inoxydable

Compartiment de réserve

Dim. : L. 85 x P. 33 x H. 26 mm

Lot de 5 pièces

→ Ref. NA03319



Dental box

Boîte à dentier

Washable in washing machine

Autoclavable

Batch of 10 boxes

Lavable en machine

Autoclavable

Lot de 10 boîtes

→ Ref. NA03220

Daily and weekly medicine dispensers

Piluliers journaliers et hebdomadaires

Dolcimo® Pocket display

Présentoir Dolcimo® pocket

Display composed of 60 pieces:

- 12 weekly medicine dispensers - large model
- 6 weekly medicine dispensers - medium model
- 12 weekly medicine dispensers - small model
- 12 daily medicine dispensers - large model
- 12 daily medicine dispensers - small model
- 4 pill splitters
- 2 pill crushers

Présentoir de 60 pièces :

- 12 piluliers journaliers petit modèle
- 12 piluliers journaliers grand modèle
- 12 piluliers hebdomadaires petit modèle
- 6 piluliers hebdomadaires moyen modèle
- 12 piluliers hebdomadaires grand modèle
- 4 coupeurs
- 2 broyeurs

→ Ref. NA03103



Dolcimo® 24 display

Présentoir Dolcimo® 24

Display of 12 daily medicine dispensers
Universal model

Dim. of display: L. 105 x D. 110 x H. 257 mm

Dim. of pill dispenser: L. 29 x D. 134 x H. 26 mm

Présentoir de 12 piluliers journaliers
Modèle universel

Dim. présentoir : L. 105 x P. 110 x H. 257 mm

Dim. pilulier : L. 29 x P. 134 x H. 26 mm

→ Ref. 538000VP



► Simple pressure opening

Ouverture par simple pression



Dolcimo® 7 weekly medical dispenser
Pilulier hebdomadaire Dolcimo® 7

Tray composed of 7 medicine dispensers
 Dolcimo 7 delivered with 1 weekly sheet of labels
 Available in different languages
 Dim. of tray : L. 226 x D. 140 x H. 45 mm
 Dim. of pill dispenser: L. 29 x D. 134 x H. 26 mm
Plateau composé de 7 piluliers
Fourni avec une planche d'étiquettes des 7 jours
de la semaine en 10 langues
 Dim. plateau : L. 226 x P. 140 x H. 45 mm
 Dim. pilulier : L. 29 x P. 134 x H. 26 mm
 → Ref. 539000VP

Dolcimo® Classic display
Présentoir Dolcimo® Classic

Display of 4 weekly medicine dispensers
 Universal model
 Dim. of display: L. 105 x D. 110 x H. 257 mm
 Dim. of pill dispenser: L. 150 x D. 100 x H. 22 mm
Présentoir de 4 piluliers hebdomadaires
Modèle universel
 Dim. présentoir : L. 105 x P. 110 x H. 257 mm
 Dim. pilulier : L. 150 x P. 100 x H. 22 mm
 → Ref. 507600P01



Hebdo® weekly medical dispenser
Pilulier hebdomadaire Hebdo®

Made for patients with several drug therapies
 Dimensions: L. 319 x D. 199 x H. 42 mm
Idéal pour les patients polymédiqués
 L. 319 x P. 199 x H. 42 mm
 Pill dispenser with fixed compartments
Pilulier à cases fixes
 → Ref. 505001BL
 Pill dispenser with removable dividers
Pilulier à cases réglables
 → Ref. 50610BL

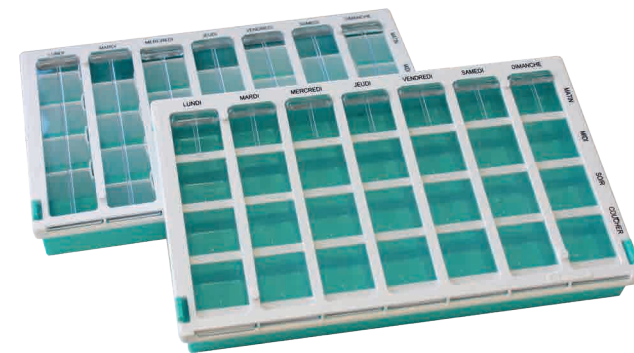



04.

Laundry and waste range

Gestion du linge et des déchets



CLEAN LAUNDRY TRANSPORT

Transport du linge propre



NURSING AND CLEAN LAUNDRY DISTRIBUTION

Distribution du linge et des changes



WASTE COLLECTION

Collecte des déchets



DIRTY LINEN COLLECTION

Collecte du linge sale



DIRTY LINEN TRANSPORT

Transport du linge sale



LAUNDRY

Blanchisserie



Linen shelving trolleys

Chariots de distribution du linge

► Anodised aluminium alloy structure and shelves

Structure et étagères en alliage d'aluminium anodisé



► Laminate swing doors with magnetic lock

Portes battantes en stratifié à fermeture magnétique

H. 1000 mm - 1 shelf
H. 1000 mm - 1 étagère

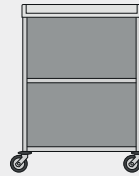

Without door
Sans porte

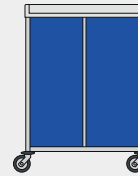

With doors
Avec portes

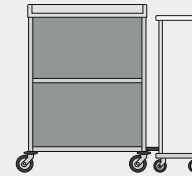

Without door, with 1-bag hamper
Sans porte, avec 1 porte-sac

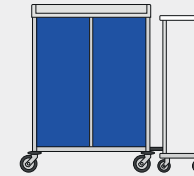

With doors and 1-bag hamper
Avec portes et 1 porte-sac

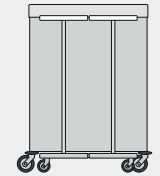

With doors and 2-bag hamper
Avec portes et 2 porte-sacs

H. 1190 mm - 2 shelves
H. 1190 mm - 2 étagères



Without door
Sans porte

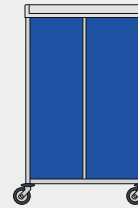

With doors
Avec portes

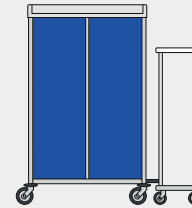

With doors and 1-bag hamper
Avec portes et 1 porte-sac

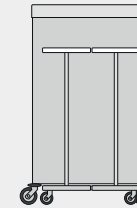

With doors and 2-bag hamper
Avec portes et 2 porte-sacs

H. 1420 mm - 2 shelves
H. 1420 mm - 2 étagères



With doors
Avec portes

► Many compatible accessories such as the upper divider adaptable inside and outside of the trolley

Nombreux accessoires compatibles tels que le trieur adaptable à l'extérieur et à l'intérieur du chariot



Trolley with doors and 1 shelf
Chariot à portes avec 1 étagère

→ Ref. AJ12000



Cabinet with doors and 2 shelves
Armoire à portes avec 2 étagères

→ Ref. AJ12027



Trolley with doors, 1 shelf et 2-bag hamper
Chariot à portes avec 1 étagère et 2 porte-sacs

→ Ref. AJ12011

Room trolleys

Chariots de change



▶ Ø 30 mm tubular structure
made of machine-welded
steel epoxy coating

*Structure en tube acier
Ø 30 mm traitée anticorrosion
par un revêtement époxy*

▶ Available colours

Coloris disponibles



Mini trolley - 15 to 20 patients

Chariot Mini - 15 à 20 patients

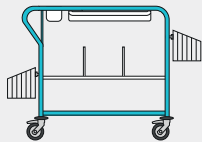

Open trolley
Chariot ouvert

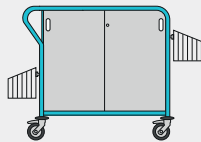

Trolley with doors
Chariot à portes

Classic trolley - 20 to 30 patients

Chariot Classic - 20 à 30 patients

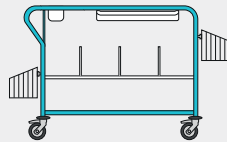

Open trolley
Chariot ouvert

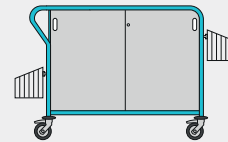

Trolley with doors
Chariot à portes

EasyMove

▶ **MOTORISATION** of the trolleys
to help you limit MSDs and
improve the comfort for
healthcare professionals

Solution de MOTORISATION
des chariots permettant de limiter
les TMS et d'améliorer le CONFORT
de travail du personnel soignant



Available option on all
our nursing trolley models

*Option disponible sur tous
nos modèles de chariots de change*

Closed nursing trolley with doors
Chariot de change à portes

Standard equipments:

- 1 small built-in tray on upper shelf
- 2 lateral big wire baskets
- 1 middle removable adjustable shelf with dividers

Équipements de série :

- 1 bac de pioche encastrable
- 2 paniers latéraux grand modèle
- 1 étagère amovible avec séparateurs

Nursing trolley 15 to 20 patients

Chariot 15 à 20 patients

→ Ref. 8P200XX_P

Nursing trolley 20 to 30 patients

Chariot 20 à 30 patients

→ Ref. 8P100XX_P



Open nursing trolley
Chariot de change ouvert

Standard equipments:

- 1 sliding drawer under upper shelf
- 1 small built-in tray on upper shelf
- 2 lateral big wire baskets
- 1 middle removable adjustable shelf with dividers

Équipements de série :

- 1 tiroir 600 x 400 sous plateau
- 1 bac de pioche encastrable
- 2 paniers latéraux grand modèle
- 1 étagère amovible avec séparateurs

Nursing trolley 15 to 20 patients

Chariot 15 à 20 patients

→ Ref. 8P200XX

Nursing trolley 20 to 30 patients

Chariot 20 à 30 patients

→ Ref. 8P100XX



► Many compatible accessories
 such as upper divider for nappies

*Nombreux accessoires compatibles
 tels que le trieur de change*



Laundry hampers

Chariots support-sacs



1-bag hamper
Chariot 1 sac

With lid and pedal
Couvercle à commande au pied
→ Ref. AB12142



2-bag hamper
Chariot 2 sacs

Without lid
Sans couvercle
→ Ref. AB12150

With lids
Couvercles à commande manuelle
→ Ref. AB12151

With lids and pedals
Couvercles à commande au pied
→ Ref. AB12152



3-bag hamper
Chariot 3 sacs

With lids
Couvercles à commande manuelle
→ Ref. AB12161

With lids and pedals
Couvercles à commande au pied
→ Ref. AB12162

Lids

Couvercles

Several colours are available to sort the different linen: yellow, green, red, white and blue.

Cinq couleurs vous sont proposées pour effectuer le tri du linge (pour séparer les différents types de linge) : jaune, vert, rouge, blanc et bleu.



4-bag hamper

Chariot 4 sacs en ligne

Without lid
Sans couvercle
→ Ref. AB12170

With lids and pedals
Couvercles à commande au pied
→ Ref. AB12172



Back-to-back 4-bag hamper

Chariot 4 sacs dos à dos

Without lid
Sans couvercle
→ Ref. AB12180

With lids
Couvercles à commande manuelle
→ Ref. AB12181

With lids and pedals
Couvercles à commande au pied
→ Ref. AB12182



Linen bags

Sacs à linge

- → Ref. AB29370.10
- → Ref. AB29370.20
- → Ref. AB29370.30
- → Ref. AB29370.40
- Ref. 22100_S

Clamp collection trolleys

Chariots à pince

- ▶ Thanks to their hermetic closure, our clamp collection trolleys contribute to decrease the risks of air-biocontamination. These clamp collection trolleys can be permanently or temporarily fixed on our laundry hampers, our linen distribution trolleys and our room trolleys. Care assistants can then collect both linen and waste.

Avec leur fermeture hermétique, nos chariots à pince contribuent à diminuer les risques de l'aéro-biocontamination. Ces collecteurs peuvent être fixés, de façon permanente ou provisoire, sur nos chariots support-sacs, nos chariots de distribution du linge et nos chariots de change. Les aides-soignantes peuvent alors collecter le linge en même temps que les déchets.



Clamp collection trolley
Chariot à pince

Trolley big model for bags from 70 to 120 L
Chariot grand modèle pour sacs de 70 à 120 L
→ Ref. AB11080

Trolley small model for bags from 40 to 80 L
Chariot petit modèle pour sacs de 40 à 80 L
→ Ref. AB11082



**Removable attaching device
for distribution trolley**

**Adaptation amovible pour
chariot de distribution**
→ Ref. AB04004



**Fixed attaching device
for in line laundry hampers**

**Adaptation fixe pour chariot
porte-sacs en ligne**
→ Ref. AB04001

Dirty linen trolleys

Chariots de collecte du linge



Trolley with spring-loaded bottom

Chariot à fond remoyant

Anodised aluminium structure
 Solid torsion-resistant frame
 Light aluminium bumper
 4 wheels Ø 125 mm

*Structure en alliage d'aluminium anodisé
 Châssis anti-torsion très robuste
 Pare-chocs périphérique en alliage léger
 4 roues Ø 125 mm*

223 L → Ref. AF12000
 336 L → Ref. AF12001



Trolley with fixed bottom

Chariot à fond fixe

Anodised aluminium structure
 Solid torsion-resistant frame
 Perimeter rubber bumper
 4 wheels Ø 160 mm
 Drain valve
 2/3 lid opening

*Structure en alliage d'aluminium anodisé
 Châssis anti-torsion très robuste
 Pare-chocs périphérique en caoutchouc
 4 roues Ø 160 mm
 Robinet de vidange
 Couvercle 2/3 ouvrant avec arrêt de sécurité*

699 L → Ref. AF12020
 987 L → Ref. AF12021



Roll trolley

Roll à linge

Zinc-plated steel structure
 4 wheels Ø 100 mm
 Capacity: 500 kg
 Optional shelves and sides

*Structure en acier zingué
 4 roues Ø 100 mm
 Capacité : 500 kg
 Étagères et côtés en option*

Standard → Ref. AF12100
 Maxi → Ref. AF12101

Linen transport cabinets

Armoires de transport du linge

- For the distribution of clean linen in your establishment, we propose you a wide range of transport cabinets. As they are fully made of anodised aluminum, our cabinets are robust, light and easy to use. They are designed with a rigid body with all round lower grey rubber bumpers. The doors can be opened at 270° and are maintained with a door retainer.

Pour distribuer le linge propre au sein de votre établissement, nous vous proposons différentes armoires de transport. Complètement réalisées en alliage d'aluminium anodisé, nos armoires sont solides, légères et faciles à guider. Munies d'un châssis anti-torsion très robuste, elles possèdent également un pare-chocs périphérique caoutchouc en partie basse. Leurs portes, s'ouvrant à 270°, sont maintenues en position ouverte par un aimant.



1-shelf cabinet

Armoire avec 1 étagère

L. 1230 x D. 630 x H. 1200 mm
4 wheels Ø 160 mm

L. 1230 x P. 630 x H. 1200 mm
4 roues Ø 160 mm sans frein

→ Ref. AE12000



2-shelf cabinet

Armoire avec 2 étagères

L. 1230 x P. 630 x H. 1500 mm
4 wheels Ø 200 mm

L. 1230 x P. 630 x H. 1500 mm
4 roues Ø 200 mm sans frein

→ Ref. AE12001



2-shelf cabinet

Armoire avec 2 étagères

L. 1230 x D. 630 x H. 1740 mm
4 wheels Ø 200 mm

L. 1230 x P. 630 x H. 1740 mm
4 roues Ø 200 mm sans frein

→ Ref. AE12002

Wire chromed trolleys and shelving systems

Chariots et rayonnage en fil chromé

► Very robust and easy to assemble, our chromed steel wire range is completely customizable. For linen storage, we offer you fixed or sliding wire chromed shelving systems. Our linen distribution trolleys are equipped with dividers for a personalized linen distribution. A push handle bar can be settled to facilitate the transfer.

Très solide et facile à monter, notre gamme en fil d'acier chromé est totalement personnalisable. Pour stocker le linge, nous vous proposons du rayonnage fixe ou coulissant. Nos chariots distri-linge sont, quant à eux, dotés de séparateurs permettant une distribution nominative du linge. Ils peuvent aussi être équipés d'une poignée de poussée pour faciliter leur déplacement.



Trolley with cloth hanging rod for personal linen distribution
Chariot avec barre penderie pour la distribution du linge personnel

→ Ref. AH10207



Trolley for room services
Chariot pour l'approvisionnement des services d'étages

→ Ref. AH10206



20-patient distribution trolley
Chariot de distribution 20 patients



Fixed shelving system for linen storage
Rayonnage fixe pour le stockage du linge



05.

Patient file management

Gestion du dossier patient

Patient file trolleys

Chariots de visite patients



**Trolley for A4+ A3+ files
with front opening face**
Chariot pour dossiers A4+ A3+
à préhension en face avant

Closing by curtain door
Key locking system

*Fermeture par rideau coulissant
Verrouillage par serrure à clé*

▶ Removable partitions

Cloisons amovibles



Trolley for A4+ A3+ files with top opening
Chariot pour dossiers A4+ A3+
à préhension par le dessus

Closing by top opening
Key locking system
Equipped with handle

*Fermeture par tablette coulissante
Verrouillage par serrure à clé
Équipé d'une poignée*



XXL trolley for large medical files
Chariot XXL pour dossiers grand format

Closing by curtain door
Key locking system
Equipped with 2 handles

*Fermeture par rideau coulissant
Verrouillage par serrure à clé
Équipé de 2 poignées*

→ Ref. 8C010

Mobile computing stations

Stations informatiques

- ▶ Our computer stations have been designed for optimal and safe use of a computer in technical care units and CSSD. Work surface is height-adjustable and computer data input can be done in sitting or standing position.

Nos stations informatiques ont été conçues pour une utilisation optimale et en toute sécurité, d'un ordinateur au sein des unités de soins et plateaux techniques. La hauteur du plan de travail étant réglable, la saisie des données informatiques peut être effectuée en position assise ou debout.



Mobile station for laptop with safety bar

Station pour ordinateur portable avec arceau de sécurité

→ Ref. 8EIP100



Mobile station with holder for laptop

Station avec support pour ordinateur portable

→ Ref. 8EIP201



- ▶ Hydraulic height-adjustable work surface

Plan de travail ajustable en hauteur par vérin à gaz

- ▶ Aluminium and steel structure

Structure en aluminium et acier

Mobile station with Vesa support

Station avec support Vesa

→ Ref. 8EIP200

Computerisation solutions for trolleys

Solutions d'informatisation des chariots

- Computerisation of medication logistics and computerised patient file (CPF) are major issues for the establishments. For this purpose, we have a whole range of computer supports which are compatible with our entire ranges.

L'informatisation du circuit du médicament et le dossier patient informatisé (DPI) sont des enjeux majeurs pour les établissements. Dans ce cadre, PRATICIMA vous propose toute une gamme de supports informatiques compatibles avec l'ensemble de nos chariots et guéridons.



Compact holder for laptop with lid

Support en compact pour ordinateur portable avec capot de protection

For maximum 17- inch laptop

Conçu pour ordinateur de 17 pouces maximum



Compact holder for laptop without lid

Support en compact pour ordinateur portable sans capot de protection

For maximum 17- inch laptop

Conçu pour ordinateur de 17 pouces maximum

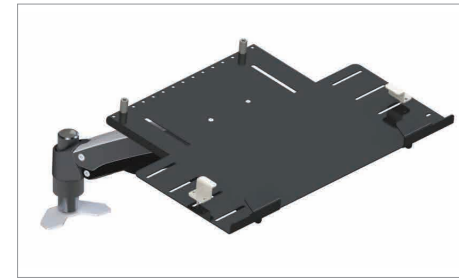

Holder for laptop made of sheet metal

Support en tôle pour ordinateur portable

For maximum 17- inch laptop

Conçu pour ordinateur de 17 pouces maximum



Tablet holder

Support pour tablette tactile

Compatible with 9 to 11 - inch touch pad

Compatible avec tablette de 9 à 11 pouces



Vesa screen holder

Support pour écran Vesa

06.

Catering management

Circuit de la restauration



Distribution motorized trolley

Chariot de distribution de repas motorisé

Neop meal



▶ 100% motorized trolley to reduce MSDs
Chariot 100% motorisé pour réduire les TMS



▶ Working surface with ergonomic height and handle on 3 sides
Plan de travail à hauteur ergonomique avec poignée sur 3 côtés

▶ Entirely in Stainless Steel
Entièrement en inox

4 available trolley models according to uses 4 déclinaisons de chariots en fonction des utilisations



HOT COLD TROLLEY CHARIOT CHAUD FROID

Meal, breakfast and brunch distribution in the bedroom, dining room or any other special rooms
Distribution des repas, petits déjeuners et goûters en chambre, en salle à manger ou en UVP



DOUBLE HOT TROLLEY CHARIOT DOUBLE CHAUD



Meal distribution in the dining room
Distribution des repas en salle à manger



DOUBLE AIR COOLED TROLLEY CHARIOT DOUBLE FROID



COOL TROLLEY CHARIOT ISOTHERME

Breakfast and brunch distribution
Distribution des petits déjeuners, goûters, navette

Guarantees food service all day long
Enables to deliver food in the bedroom, dining room or in any other special rooms
Service on individual trays or on plates from Gastronomie containers
2 compartments of GN 1/1 8 levels with 80 mm space
Maintaining temperatures by forced air
Assure les différentes prestations alimentaires de la journée
Service en chambre, en salle à manger ou en UVP
Sur plateaux individuels ou à l'assiette à partir de bacs Gastronomie
2 compartiments de 8 niveaux GN 1/1 au pas de 80 mm
Maintien des températures par air pulsé



07.

Technical aids for medical staff

Aides techniques pour le personnel

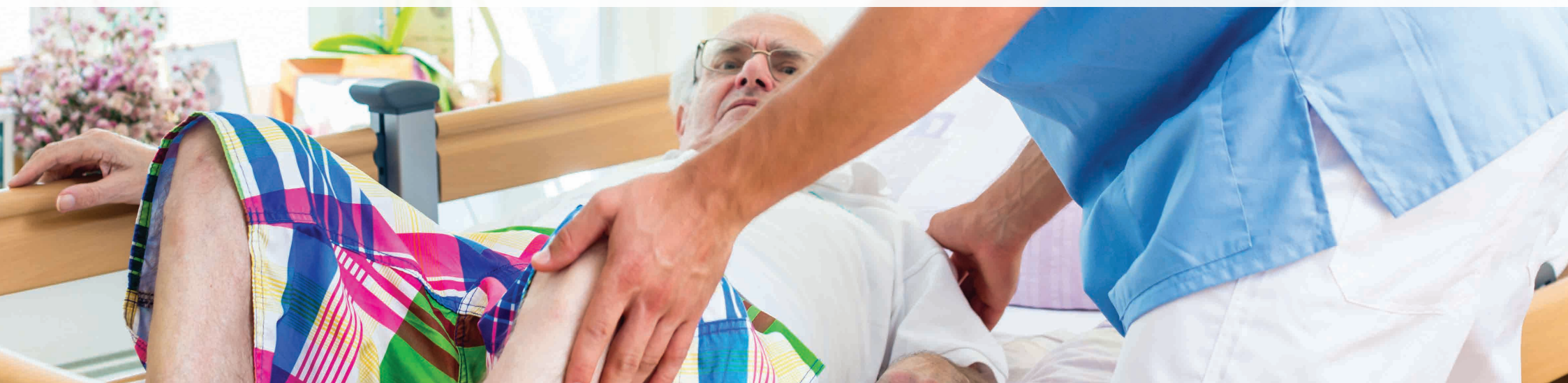

Transfer boards

Planches de transfert

- The transfer boards enable to transfer the patients without lifting them. Work conditions of medical staff can therefore be considerably improved. As they are totally x-ray translucent, these boards are ideal in medical imaging. They have a 100% waterproof nylon cover that is washable at 90°.

Les planches de transfert facilitent le déplacement des patients sans qu'il soit nécessaire de les soulever. Les conditions de travail du personnel soignant s'en trouvent considérablement améliorées. Totalement radio-transparentes, ces planches sont idéales en imagerie médicale. Elles possèdent une housse en nylon 100 % imperméable et lavable à 90°.



Scangliss® foldable board Planche pliable Scangliss®

Dimensions open: 1780 x 530 mm
Dimensions closed: 890 x 530 mm

Dim. dépliée : L. 1780 x l. 530 mm

Dim. pliée : L. 890 x l. 530 mm

→ Ref. SAA70110

Scangliss® Mini board Planche Mini Scangliss®

Ideal for emergency and gynecology departments

Dimensions: 900 x 530 mm

Idéal pour les services d'urgences et de gynécologie

Dimensions : 900 x 530 mm

→ Ref. SAA70120



Scangliss® rigid board Planche rigide Scangliss®

Ideal for operating rooms, MRI and emergency department
Dimensions: 1780 x 530 mm

Idéal en salle d'opération, en imagerie médicale et aux urgences
Dimensions : 1780 x 530 mm

→ Ref. SAA70100



Wall mounted roll support Dériveur mural

L. 690 x D. 210 x H. 130 mm

L. 690 x P. 210 x H. 130 mm

→ Ref. SAA40200



Wall mounted support Support mural

L. 410 x l. 70 x H. 600 mm

For all types of boards

L. 410 x l. 70 x H. 600 mm

Pour tous types de planches

→ Ref. SAA40250

Pinel® restraint system

Système de contention Pinel®

- ▶ The Pinel® system allows you to satisfy restraint requirements of institutions, e.g. long term care, emergency room, psychiatry, ICU or correctional facilities. The slings made of Polyester and Kevlar are very resistant, antibacterial and machine washable. Thanks to their locking systems, the Pinel® slings can quickly be set up. They can easily be unlocked thanks to a magnetic key.

Le système Pinel® permet de satisfaire les besoins de contention des institutions, soins prolongés, urgences, psychiatrie, soins intensifs... Les sangles, composées de Polyester et de Kevlar, sont très résistantes, antibactériennes et lavables en machine. Avec leur système de verrous, les fixations Pinel® sont rapides à mettre en place. Elles se débloquent aisément à l'aide d'une clé magnétique.

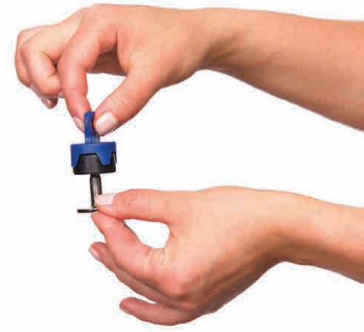

Complete kit with case Kit complet avec mallette

Kit including 30 accessories
Case equipped with a colour code which enables to easily put the different equipments

*Kit comprenant 30 accessoires
Mallette munie d'un code couleur permettant de ranger facilement tous les équipements*

→ Ref. SAA50100

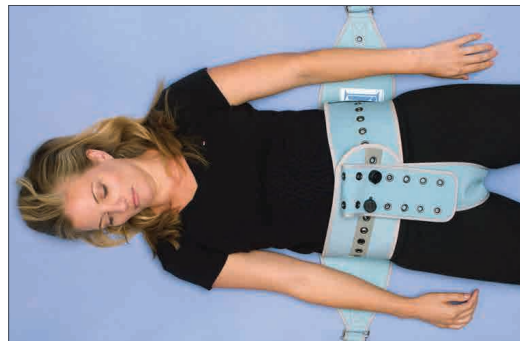

Waist strap Kit ceinture abdominale

Included: 1 waist belt, 2 free side straps, 1 pelvic strap, 3 magnetic keys, 2 pins with button, 2 pins with button and lanyard

Contient : 1 ceinture abdominale, 2 courroies latérales libres, 1 sangle pelvienne, 3 clés magnétiques, 2 axes avec verrou, 2 axes avec verrou et ficelle

*Small size / Petite taille → Ref. SAA50402
Standard size / Taille standard → Ref. SAA50400
Big size / Grande taille → Ref. SAA50401*



Limb strap Kit attache-membres

Included: 2 limb restraints, 1 magnetic key, 4 pins with button and lanyard

Contient : 2 attaches membres, 1 clé magnétique, 4 axes avec verrou et ficelle

*Small size / Petite taille → Ref. SAA50301
Standard size / Taille standard → Ref. SAA50300*



Rue du Pou du Ciel – ZI de Reyrieux
CS20129 Reyrieux – 01600 TRÉVOUX
FRANCE

Tél : +33 (0)4 74 00 98 11

Fax : +33 (0)4 74 00 98 36

E-mail : praticima@praticima.fr

www.praticima.fr



**French
Healthcare**
Association

